

JVC

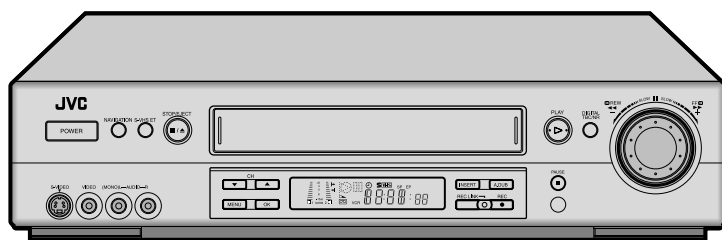

VIDEO CASSETTE RECORDER

HR-S9800U



SVHS

Hi-Fi

VCRplus+[®]
3
CABLE BOX
CONTROL

Super VHS ET

TIME SCAN

Ghost Reduction Tuner

INSTRUCTIONS

For Customer Use:

Enter below the Model No. and Serial No. which are located on the rear of cabinet. Retain this information for future reference.



Model No. _____

Serial No. _____

Dear Customer,

Thank you for purchasing the JVC S-VHS video cassette recorder. Before use, please read the safety information and precautions contained in the following pages to ensure safe use of your new VCR.

CAUTIONS

	CAUTION RISK OF ELECTRIC SHOCK DO NOT OPEN	
<p>CAUTION: TO REDUCE THE RISK OF ELECTRIC SHOCK. DO NOT REMOVE COVER (OR BACK). NO USER-SERVICEABLE PARTS INSIDE. REFER SERVICING TO QUALIFIED SERVICE PERSONNEL.</p>		



The lightning flash with arrowhead symbol, within an equilateral triangle, is intended to alert the user to the presence of uninsulated "dangerous voltage" within the product's enclosure that may be of sufficient magnitude to constitute a risk of electric shock to persons.



The exclamation point within an equilateral triangle is intended to alert the user to the presence of important operating and maintenance (servicing) instructions in the literature accompanying the appliance.

WARNING:
TO PREVENT FIRE OR SHOCK HAZARD, DO NOT EXPOSE THIS UNIT TO RAIN OR MOISTURE.

CAUTION:

This video cassette recorder should be used with AC 120V~, 60Hz only.

To prevent electric shocks and fire hazards, DO NOT use any other power source.

CAUTION:

TO PREVENT ELECTRIC SHOCK, MATCH WIDE BLADE OF PLUG TO WIDE SLOT, FULLY INSERT.

ATTENTION:

POUR ÉVITER LES CHOCS ÉLECTRIQUES, INTRODUIRE LA LAME LA PLUS LARGE DE LA FICHE DANS LA BORNE CORRESPONDANTE DE LA PRISE ET POUSSER JUSQU'AU FOND.

Note to CATV system installer:

This reminder is provided to call the CATV system installer's attention to Article 820-40 of the NEC that provides guidelines for proper grounding and, in particular, specifies that the cable ground shall be connected to the grounding system of the building, as close to the point of cable entry as practical.

CAUTION:

Changes or modifications not approved by JVC could void user's authority to operate the equipment.

Declaration of Conformity

Model Number :HR-S9800U
Trade Name :JVC
Responsible Party :JVC Americas Corp.
Address :1700 Valley Road Wayne, N.J. 07470
Telephone Number :973-315-5000

This device complies with Part 15 of FCC Rules.

Operation is subject to the following two conditions:

- (1) This device may not cause harmful interference, and (2) this device must accept any interference received, including interference that may cause undesired operation.

Failure to heed the following precautions may result in damage to the VCR, Remote or video cassette.

1. DO NOT place the VCR . . .

- ... in an environment prone to extreme temperatures or humidity.
- ... in direct sunlight.
- ... in a dusty environment.
- ... in an environment where strong magnetic fields are generated.
- ... on a surface that is unstable or subject to vibration.

2. DO NOT block the VCR's ventilation openings.**3. DO NOT place heavy objects on the VCR or on the Remote.****4. DO NOT place anything which might spill on the top of the VCR or on the Remote.****5. AVOID violent shocks to the VCR during transport.**

VCR Plus+, C³ and PlusCode are registered trademarks of Gemstar Development Corporation.

The VCR Plus+ system is manufactured under license from Gemstar Development Corporation.

DSS™ is an official trademark of DIRECTV, Inc., a unit of GM Hughes Electronics. PRIMESTAR is a registered service mark of Primestar Partners, L.P. DISH Network™ is a trademark of EchoStar Communications Corporation.



- Cassettes marked "S-VHS" and "VHS" can be used with this video cassette recorder. However, S-VHS recordings are possible only with cassettes marked "S-VHS". By using S-VHS ET it is possible to record and play back with S-VHS picture quality on VHS cassettes with this VCR.
- As an ENERGY STAR® Partner, JVC has determined that this product or product model meets the ENERGY STAR® guidelines for energy efficiency.

IMPORTANT PRODUCT SAFETY INSTRUCTIONS

Electrical energy can perform many useful functions. But improper use can result in potential electrical shock or fire hazards. This product has been engineered and manufactured to assure your personal safety. In order not to defeat the built-in safeguards, observe the following basic rules for its installation, use and servicing.

ATTENTION:

Follow and obey all warnings and instructions marked on your product and its operating instructions. For your safety, please read all the safety and operating instructions before you operate this product and keep this booklet for future reference.

INSTALLATION

1. Grounding or Polarization

(A) Your product may be equipped with a polarized alternating-current line plug (a plug having one blade wider than the other). This plug will fit into the power outlet only one way. This is a safety feature.

If you are unable to insert the plug fully into the outlet, try reversing the plug. If the plug should still fail to fit, contact your electrician to replace your obsolete outlet. Do not defeat the safety purpose of the polarized plug.

(B) Your product may be equipped with a 3-wire grounding-type plug, a plug having a third (grounding) pin. This plug will only fit into a grounding-type power outlet. This is a safety feature.

If you are unable to insert the plug into the outlet, contact your electrician to replace your obsolete outlet. Do not defeat the safety purpose of the grounding-type plug.

2. Power Sources

Operate your product only from the type of power source indicated on the marking label. If you are not sure of the type of power supply to your home, consult your product dealer or local power company. If your product is intended to operate from battery power, or other sources, refer to the operating instructions.

3. Overloading

Do not overload wall outlets, extension cords, or integral convenience receptacles as this can result in a risk of fire or electric shock.

4. Power Cord Protection

Power supply cords should be routed so that they are not likely to be walked on or pinched by items placed upon or against them, paying particular attention to cords at plugs, convenience receptacles, and the point where they exit from the product.

5. Ventilation

Slots and openings in the cabinet are provided for ventilation. To ensure reliable operation of the product and to protect it from overheating, these openings must not be blocked or covered.

- Do not block the openings by placing the product on a bed, sofa, rug or other similar surface.
- Do not place the product in a built-in installation such as a bookcase or rack unless proper ventilation is provided or the manufacturer's instructions have been adhered to.

6. Wall or Ceiling Mounting

The product should be mounted to a wall or ceiling only as recommended by the manufacturer.

ANTENNA INSTALLATION INSTRUCTIONS

1. Outdoor Antenna Grounding

If an outside antenna or cable system is connected to the product, be sure the antenna or cable system is grounded so as to provide some protection against voltage surges and built-up static charges. Article 810 of the National Electrical Code, ANSI/NFPA 70, provides information with regard to proper grounding of the mast and supporting structure, grounding of the lead-in wire to an antenna discharge unit, size of grounding connectors, location of antenna discharge unit, connection to grounding electrodes, and requirements for the grounding electrode.

2. Lightning

For added protection for this product during a lightning storm, or when it is left unattended and unused for long periods of time, unplug it from the wall outlet and disconnect the antenna or cable system. This will prevent damage to the product due to lightning and power-line surges.

3. Power Lines

An outside antenna system should not be located in the vicinity of overhead power lines or other electric light or power circuits, or where it can fall into such power lines or circuits. When installing an outside antenna system, extreme care should be taken to keep from touching such power lines or circuits as contact with them might be fatal.

EXAMPLE OF ANTENNA GROUNDING AS PER NATIONAL ELECTRICAL CODE, ANSI/NFPA 70

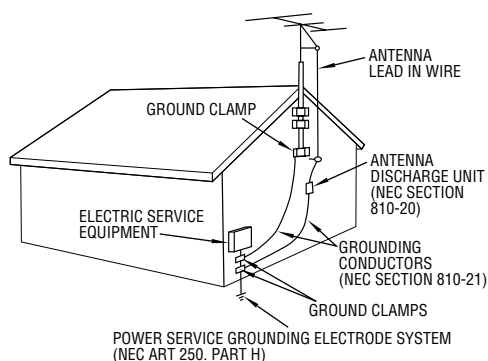

NEC – NATIONAL ELECTRICAL CODE

USE

1. Accessories

To avoid personal injury:

- Do not place this product on an unstable cart, stand, tripod, bracket, or table. It may fall, causing serious injury to a child or adult, and serious damage to the product.
- Use only with a cart, stand, tripod, bracket, or table recommended by the manufacturer or sold with the product.
- Use a mounting accessory recommended by the manufacturer and follow the manufacturer's instructions for any mounting of the product.
- Do not try to roll a cart with small casters across thresholds or deep-pile carpets.

2. Product and Cart Combination

A product and cart combination should be moved with care. Quick stops, excessive force, and uneven surfaces may cause the product and cart combination to overturn.

PORTABLE CART WARNING
(Symbol provided by RETAC)



3. Water and Moisture

Do not use this product near water—for example, near a bath tub, wash bowl, kitchen sink or laundry tub, in a wet basement, or near a swimming pool and the like.

4. Object and Liquid Entry

Never push objects of any kind into this product through openings as they may touch dangerous voltage points or short-out parts that could result in a fire or electric shock. Never spill liquid of any kind on the product.

5. Attachments

Do not use attachments not recommended by the manufacturer of this product as they may cause hazards.

6. Cleaning

Unplug this product from the wall outlet before cleaning. Do not use liquid cleaners or aerosol cleaners. Use a damp cloth for cleaning.

7. Heat

The product should be situated away from heat sources such as radiators, heat registers, stoves, or other products (including amplifiers) that produce heat.

SERVICING

1. Servicing

If your product is not operating correctly or exhibits a marked change in performance and you are unable to restore normal operation by following the detailed procedure in its operating instructions, do not attempt to service it yourself as opening or removing covers may expose you to dangerous voltage or other hazards. Refer all servicing to qualified service personnel.

2. Damage Requiring Service

Unplug this product from the wall outlet and refer servicing to qualified service personnel under the following conditions:

- a. When the power supply cord or plug is damaged.
- b. If liquid has been spilled, or objects have fallen into the product.
- c. If the product has been exposed to rain or water.
- d. If the product does not operate normally by following the operating instructions. Adjust only those controls that are covered by the operating instructions as an improper adjustment of other controls may result in damage and will often require extensive work by a qualified technician to restore the product to its normal operation.
- e. If the product has been dropped or damaged in any way.
- f. When the product exhibits a distinct change in performance—this indicates a need for service.

3. Replacement Parts

When replacement parts are required, be sure the service technician has used replacement parts specified by the manufacturer or which have the same characteristics as the original part. Unauthorized substitutions may result in fire, electric shock or other hazards.

4. Safety Check

Upon completion of any service or repairs to this product, ask the service technician to perform safety checks to determine that the product is in safe operating condition.

HOW TO USE THIS INSTRUCTION MANUAL

- The Index on pages 78 – 81 lists frequently-used terms, and the number of the page on which they are used or explained in the manual. This section also illustrates the controls and connections on the front and rear panel, the front display panel and the Remote.
- The  mark signals a reference to another page for instructions or related information.
- Operation buttons necessary for the various procedures are clearly indicated through the use of illustrations at the beginning of each major section.

BEFORE YOU INSTALL YOUR NEW VCR . . .

. . . please read the sections/literature listed below.

- "CAUTIONS" on page 2.
- "IMPORTANT PRODUCT SAFETY INSTRUCTIONS" on the previous page.

INSTALLING YOUR NEW VCR	6
Basic Connections	6
INITIAL SETTINGS	8
Plug & Play Setting	8
Auto Clock/Auto Tuner Set	8
Language Setting	9
Clock Setting	10
Preparations	10
Setting clock semiautomatically	
— Semiauto Clock Set	11
Setting clock manually — Manual Clock Set	12
Tuner Setting	13
Setting channels automatically	
— Auto Channel Set	13
Setting channels manually	
— Manual Channel Set	14
Setting ghost reduction	15
Cable Box Control Setting	16
Installing Controller	16
Setting cable box output channel & brand	17
DBS Receiver Control Setting	20
Installing Controller	20
Setting DBS receiver output channel & brand	21
BASIC PLAYBACK AND RECORDING	23
Basic Playback	23
Basic Playback Features	24
Changing display information	24
Checking tape position	24
Playing back tape repeatedly — Repeat Play	25
Adjusting tracking condition	
— Tracking Adjustments	25
Selecting monitor sound — Audio Monitor	25
Automatic operations after rewinding	
— Next Function Memory	25
Locating beginning of recordings — Index Search	26
Locating beginning of timer recordings	
— Instant Review	26
Skipping unwanted portions — Skip Search	27
Adjusting picture condition — Digital TBC/NR	27
Basic Recording	28
Basic Recording Features	30
Changing display information	30
Specifying recording length	
— Instant Timer Recording (ITR)	30
Watching one program while recording another	31
Showing on-screen display	31
Recording on VHS tapes with S-VHS quality	
— Super VHS ET	31
Adjusting recording level	32
SPECIAL EFFECT PLAYBACK	34
Special Effect Playback	34
Locating particular scene rapidly — Picture Search	34
■ High-Speed Picture Search	34
■ Variable-Speed Picture Search	35
Viewing still picture — Still Picture Playback	35
Viewing still picture frame by frame	
— Frame-by-Frame Playback	35
Viewing slow motion picture	
— Slow Motion Playback (Pro-Slow)	36
TimeScan function	37
TIMER RECORDING	38
VCR Plus+® Timer Programing	38
Changing VCR Plus+ Setting	40

Express Timer Programing	42
Checking program settings	44
Canceling or changing program settings	44
When programs overlap each other	45
VIDEO NAVIGATION	46
Navigation Playback	46
Deactivating Video Navigation	47
Editing Titles	48
Editing tape title	48
Editing program title and category	49
Deleting tape information	50
Deleting program information	51
Checking memory	51
Finding Tapes	52
Finding by tape number	52
Finding by recording date	53
Finding by category	53
Finding by remaining time	54
OTHER USEFUL FUNCTIONS	56
Useful Function Settings	56
■ VIDEO CALIBRATION	57
■ PICTURE CONTROL	57
■ AUTO TIMER	57
■ SUPERIMPOSE	57
■ AUTO SP→EP TIMER	58
■ DIGITAL R3	58
■ VIDEO STABILIZER	58
■ 2ND AUDIO RECORD	58
■ AUDIO MONITOR	59
■ S-VHS MODE	59
■ AV COMPU-LINK	59
■ TIMESCAN AUDIO	60
■ FRONT AUX INPUT	60
■ REAR AUX INPUT	60
Satellite Auto Recording	61
Child Lock	62
JLIP ID Number Setting	63
EDITING	64
Edit From Camcorder	64
Edit To Or From Another VCR	66
Audio Dubbing	67
Insert Editing and AV Dubbing	68
MULTI-BRAND REMOTE CONTROL	70
TV Brand Setting	70
Cable Box Brand Setting	71
DBS Receiver Brand Setting	72
Changing Remote Control Code	73
TROUBLESHOOTING	74
Questions and answers	77
INDEX	78
List of terms	78
Front panel	79
Front display panel	79
Rear panel	80
On-screen display	80
Remote	81
SPECIFICATIONS	82
FOR SERVICING (Only in U.S.A.)	83
WARRANTY (Only in U.S.A.)	84

Basic Connections

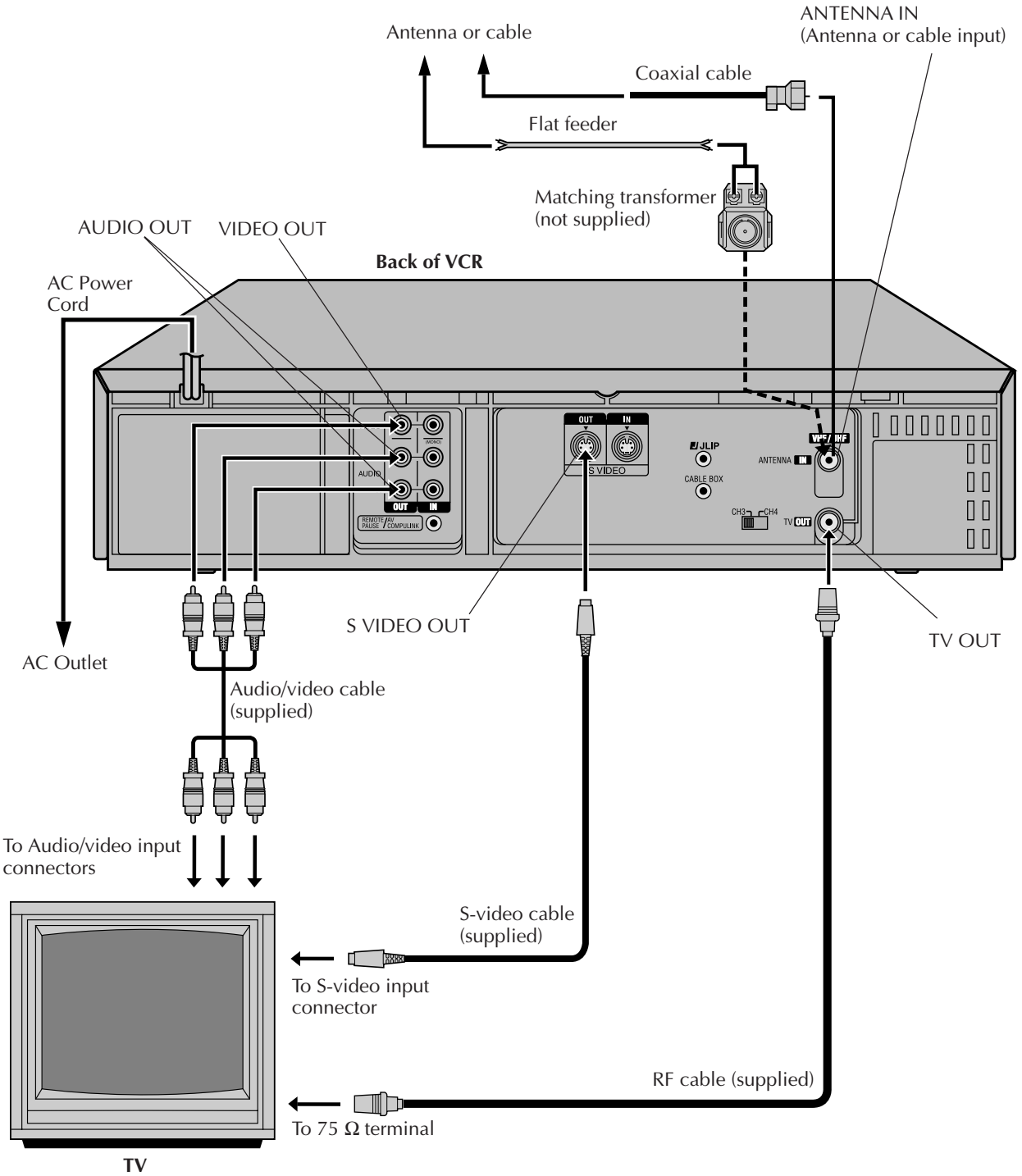

Check contents

Make sure the package contains all of the accessories listed in "SPECIFICATIONS" (☞ pg. 82).

Situate VCR

Place the VCR on a stable, horizontal surface.

Connect VCR to TV

The following connections are required.

RF Connection

- ❶ Disconnect the TV antenna from the TV.
- ❷ Connect the TV antenna cable to the ANTENNA IN terminal on the rear of the VCR.
- ❸ Connect the supplied RF cable between the TV OUT terminal on the rear of the VCR and the TV's antenna input terminal.

AV Connection (improves picture quality during tape playback.)

If your TV is equipped with audio/video input connectors

- ❶ Connect the antenna, VCR and TV as shown in the illustration.
- ❷ Connect an audio/video cable between the AUDIO/VIDEO OUT connectors on the rear of the VCR and the audio/video input connectors on the TV.

S-video Connection (allows you to make the most of the S-VHS picture performance.)

If your TV is equipped with an S-video input connector

- ❶ Perform "RF Connection" and "AV Connection" above.
- ❷ Connect an S-video cable between the S VIDEO OUT connector on the rear of the VCR and the S-video input connector on the TV.

Connect VCR to power source

Connect the AC power plug to an AC outlet.

- The clock and tuner channels will automatically be set when the antenna is connected and when the AC power cord is first connected to an AC power outlet (☞ pg. 8). (If "Auto" or "CH" is displayed on the front display panel before the VCR is turned on, the clock and tuner channels are being set automatically. Wait until the clock time is displayed on the front display panel before turning on the VCR.)

Final preparation for use

Turn on the VCR and set the CH3-CH4 switch on the rear (shown below) to either CH3 or CH4 correctly.

- The CH3-CH4 switch is preset to the CH3 position.
Set to CH4 if CH3 is used for broadcasting in your area. (To view the picture from this VCR through this channel, select the same channel on the TV with the CH3-CH4 switch setting on the VCR.)
- You can now perform basic playback (☞ pg. 23) or basic recording (☞ pg. 28).

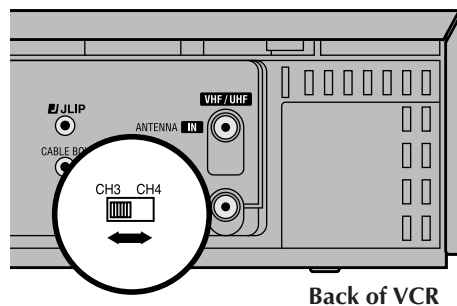

NOTES:

- The VCR channel is the channel on which you can watch the picture from the VCR on the TV when only using the RF connection. The VCR's CH3-CH4 switch, on the back of the VCR, sets the VCR channel to CH3 or CH4.
- Even if you are using audio/video cables to connect your VCR to your TV, you must also connect it using the RF cable. This will ensure that you can record one show while watching another (☞ pg. 31).
- For full identification of the VCR's rear panel, refer to the Index (☞ pg. 80).

Plug & Play Setting

Auto Clock Set/Auto Tuner Set

ATTENTION

- If you use a cable box, Plug & Play will not function; set the clock and tuner channels separately. (☞ pg.10 – 15)
- It takes several minutes for the VCR to complete the Plug & Play setting.
- Do not press any buttons on the front panel or on the Remote while Plug & Play is in progress.

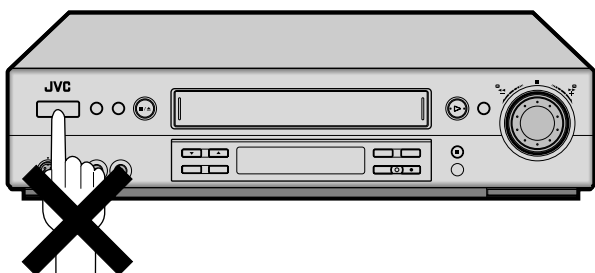

This VCR sets the clock and tuner channels automatically when AC power cord is first connected to an AC outlet. The antenna cable must be connected for the Plug & Play setting.

The time and date can be set automatically by the clock setting data transmitted from one of the regular TV broadcast channels. We call this TV channel the “host channel” and it is a PBS channel in your area.

Perform Plug & Play setup

Connect the antenna cable to the VCR (☞ pg. 6). Then connect the AC power cord to an AC outlet. Do not turn on the VCR.

The clock and tuner channels will be set automatically.

NOTES:

- *Auto Clock Set is performed first. “Auto” blinks on the front display panel during Auto Clock Set.*
- *Auto Channel Set is performed next. Auto Channel Set scans all the channels that are receivable by your VCR. During Auto Channel Set, the channel numbers are displayed as they are scanned and set.*
- *When Plug & Play setting has been complete successfully, the correct clock time is displayed. If you perform Plug & Play setting successfully, there is no need to perform the clock (☞ pg. 10) and tuner (☞ pg. 13) settings. If, however, you want to add or delete channels, and use the ghost reduction function, refer to Manual Channel Set on pages 14 and 15.*

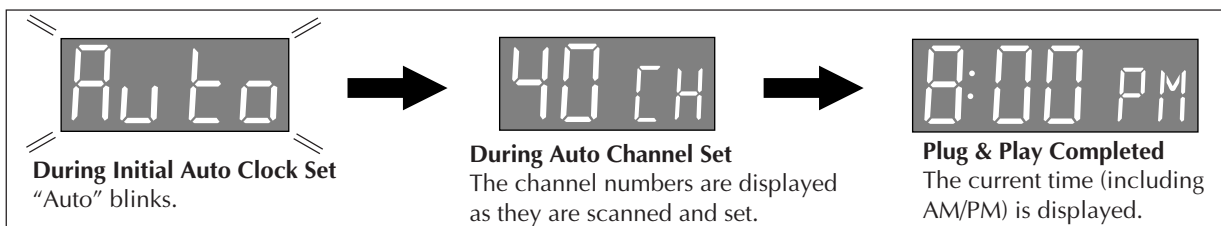

* If an incorrect clock time or “- :- -” appears on the display panel, see “What to do if Plug & Play setting failed” below.

INFORMATION

- If “AUTO CLOCK” is set to “ON” on the Clock Set screen on page 11, the clock will be adjusted automatically by the host channel every hour (except 11:00 PM, midnight, 1:00 AM and 2:00 AM) using the incoming PBS channel clock setting data. (This automatic clock adjustment can only be performed when the VCR is turned off. The clock will be adjusted just on these hours — on the time displayed on the front display panel, not on the actual real time.) The default setting of “AUTO CLOCK” is “ON”.
- If the memory backup fails, because a power outage occurs or because the AC power cord is unplugged, Plug & Play will be performed when power is restored to the VCR.
- Poor antenna or cable signal may prevent the VCR from receiving the Auto clock setting data from the PBS channel. If this function is taking a considerable amount of time, it may be necessary to perform the Semiauto or Manual Clock Set procedure.

What to do if Plug & Play setting failed

- If an incorrect time is displayed on the front display panel, you may be receiving the clock setting data of a PBS channel from an adjacent time zone, or an incorrect PBS channel from a cable TV system. In this case, perform the Semiauto (☞ pg. 11) or Manual Clock Set (☞ pg. 12) procedure.
- If “- :- -” appears on the front display panel, your antenna cable may not be connected to the VCR or there may not be a Host PBS signal available in your area. Ensure that the antenna cable is connected correctly. Then turn on and off the VCR; the Plug & Play setting will be automatically reactivated. If Plug & Play setting is not performed though the antenna cable is connected correctly, perform Manual Clock Set (☞ pg. 12) and Auto Channel Set or Manual Channel Set (☞ pg. 13 or 14).

Language Setting

Turn on the VCR and the TV, and select the VCR channel 3 or 4 (or AV mode) on the TV.

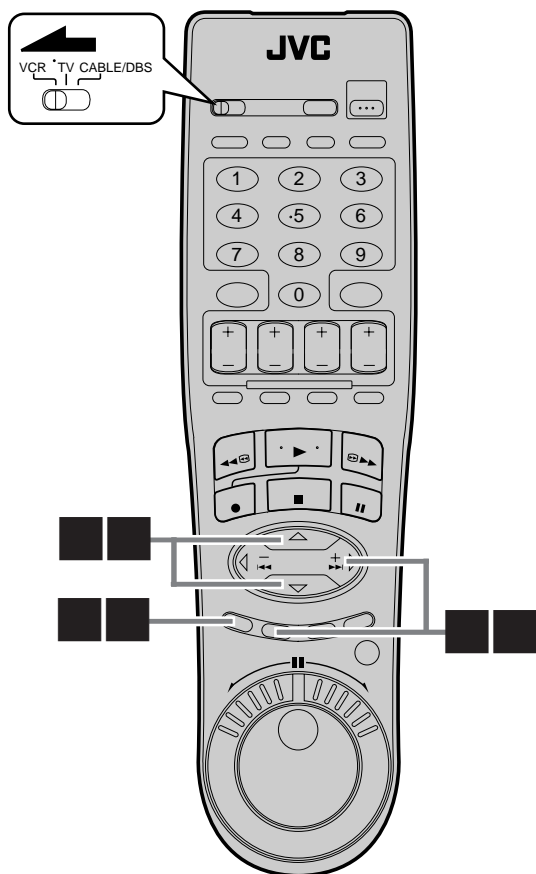
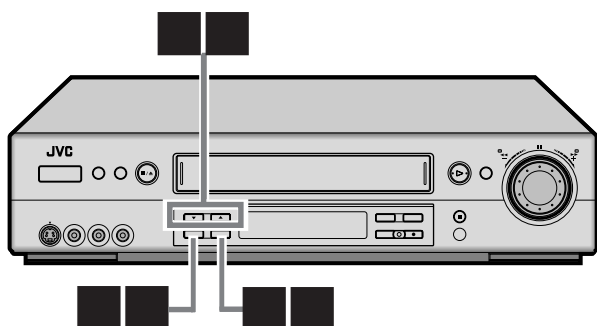

This VCR offers you the language choice to view menus and some messages — in English, Spanish or French. Select the desired language using the following procedure. The default setting is “ENGLISH”.

Access Main Menu screen

Press **MENU**.

Access Initial Set screen

On the front panel:

Press **CH▲▼** to move the highlight bar (arrow) to “INITIAL SET”, then press **OK**.

On the Remote:

Press **△▽** to move the highlight bar (arrow) to “INITIAL SET”, then press **OK** or **▷**.

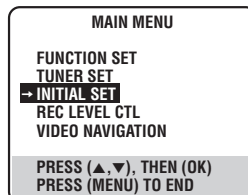

Select language

On the front panel:

Press **CH▲▼** to move the highlight bar (arrow) to “LANGUAGE”, then press **OK** repeatedly until the desired language is selected.

On the Remote:

Press **△▽** to move the highlight bar (arrow) to “LANGUAGE”, then press **OK** or **▷** repeatedly until the desired language is selected.

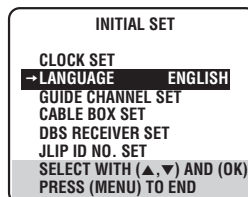

Return to normal screen

Press **MENU**.

Clock Setting

Turn on the VCR and the TV, and select the VCR channel 3 or 4 (or AV mode) on the TV.

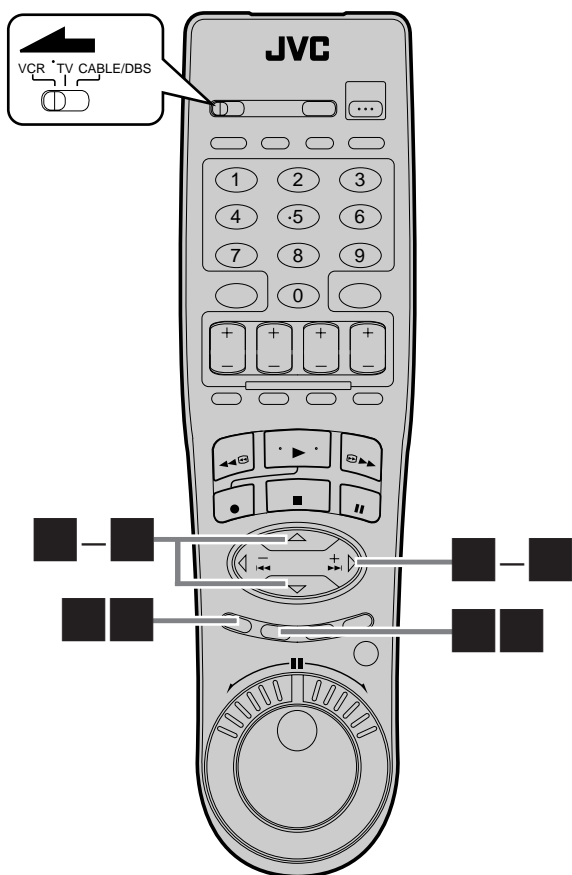
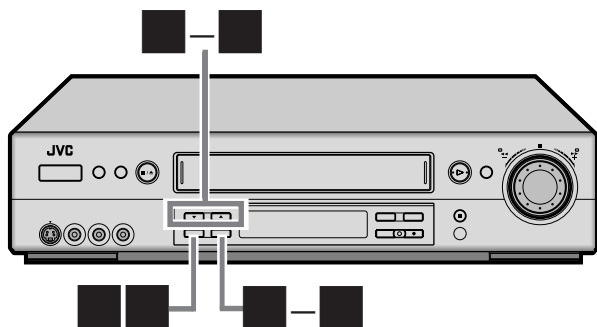

Perform clock setting only if the clock has not been set correctly by the Plug & Play setting or if you use a cable box.

Access the Clock Set screen to perform the Semiauto or Manual Clock Set. Each procedure starts from step ■ after preparation steps below are finished.

If you use a cable box, set the clock manually. (→ pg. 12)

Preparations

Access Main Menu screen

Press **MENU**.

Access Initial Set screen

On the front panel:

Press **CH▲▼** to move the highlight bar (arrow) to "INITIAL SET", then press **OK**.

On the Remote:

Press **▲▼** to move the highlight bar (arrow) to "INITIAL SET", then press **OK** or **▷**.

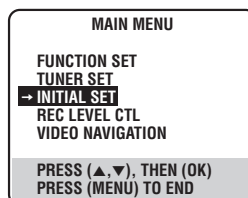

Access Clock Set screen

On the front panel:

Press **CH▲▼** to move the highlight bar (arrow) to "CLOCK SET", then press **OK**.

On the Remote:

Press **▲▼** to move the highlight bar (arrow) to "CLOCK SET", then press **OK** or **▷**.

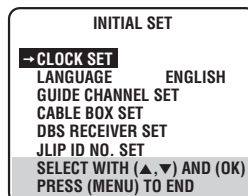

- "CABLE BOX USERS SET CLOCK MANUALLY" appears on the screen for about 5 seconds, then the Clock Set screen appears.

Setting clock semiautomatically

— Semiauto Clock Set

You can change the host channel/D.S.T./time zone setting manually.

First follow steps ■ to ■ on page 10, then go to the following steps.

Set Auto Clock to ON

On the front panel:

Press **OK** repeatedly to move the highlight bar to "AUTO CLOCK", then press **CH▲▼** so that "ON" is selected.

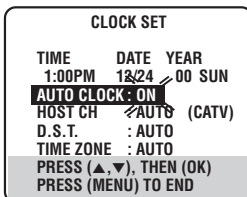

On the Remote:

Press **▷** to move the highlight bar to "AUTO CLOCK", then press **△▽** so that "ON" is selected. Then;

To select the host channel — go to step ■.

To select the D.S.T. mode — go to step ■.

To select the time zone — go to step ■.

NOTE:

The time set previously will be erased when "AUTO CLOCK", "HOST CH", "D.S.T." or "TIME ZONE" setting is changed.

Select host channel

You can either select "AUTO" or enter a PBS channel number.

On the front panel:

Press **OK** to move the highlight bar to "HOST CH", then press **CH▲▼** repeatedly until "AUTO" or the desired PBS channel number is selected.

On the Remote:

Press **▷** to move the highlight bar to "HOST CH", then press **△▽** until "AUTO" or the desired PBS channel number is selected.

NOTE:

Some PBS channels do not transmit clock setting data.

Select D.S.T. mode

You have three choices:

AUTO— Select if you want to adjust your VCR's clock automatically by the incoming signal from the host channel. (Auto Daylight Saving Time*)

ON— Adjustment will be made by the built-in clock itself.

OFF— Select when Daylight Saving Time does not apply to you.

On the front panel:

Press **OK** to move the highlight bar to "D.S.T.", then press **CH▲▼** repeatedly until the desired setting is selected.

On the Remote:

Press **▷** to move the highlight bar to "D.S.T.", then press **△▽** repeatedly until the desired setting is selected.

Select time zone

You can select the time zone automatically or manually.

On the front panel:

Press **OK** to move the highlight bar to "TIME ZONE", then press **CH▲▼** repeatedly until "AUTO" or the desired time zone is selected.

Each time you press the button, the time zone changes as follows:

↔ AUTO ↔ ATLANTIC ↔ EASTERN

↔ CENTRAL ↔ MOUNTAIN ↔ PACIFIC

↔ ALASKA ↔ HAWAII ↔ (back to the beginning)

On the Remote:

Press **▷** to move the highlight bar to "TIME ZONE", press **△▽** repeatedly until "AUTO" or the desired time zone is selected (see above).

NOTE:

If an incorrect clock time is displayed by the Plug & Play setting, you may be receiving the clock setting data of a PBS channel from an adjacent time zone or from an incorrect PBS channel from a cable TV system. If you selected "AUTO" for the host channel in step ■, be sure to select the correct time zone manually.

Return to normal screen

Press **MENU**.

* Auto Daylight Saving Time

This function enables automatic adjustment of the VCR's clock at the start and end of Daylight Saving Time.

With Auto DST activated, . . .

. . . on the first Sunday of April at 2:00 AM, the clock is adjusted to 3:00 AM.

. . . on the last Sunday of October at 2:00 AM, the clock is adjusted to 1:00 AM.

IMPORTANT

Turn off the VCR after performing Semiauto Clock Set. "Auto" will appear on the front display panel while the clock is being set. The current clock time will appear automatically when the clock setting is complete.

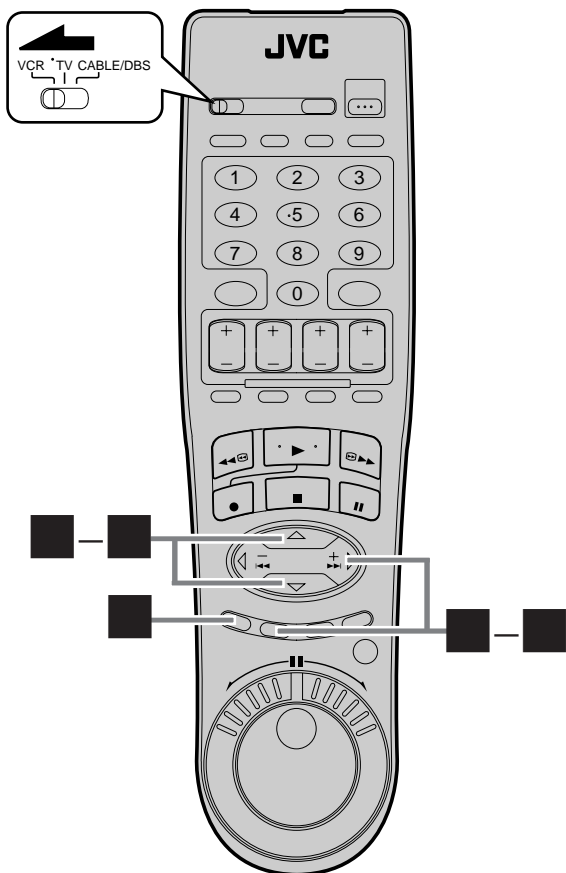
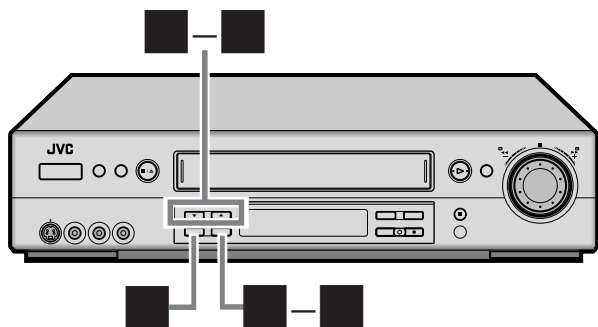

Setting clock manually

— Manual Clock Set

First follow steps ■ to ■ on page 10, then go to the following steps.

■ Set time

On the front panel:
Press **CH▲▼** until the desired time appears, then press **OK**.

On the Remote:
Press **△▽** until the desired time appears, then press **OK** or **▷**.

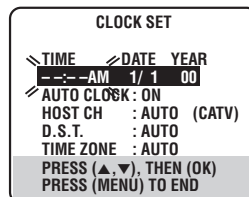

- Holding **CH ▲▼** or **△▽** changes the time in 30-minute intervals.
- When the time is entered manually, "AUTO CLOCK" is automatically set to "OFF", and "HOST CH" and "TIME ZONE" disappear.

■ Set date

On the front panel:
Press **CH ▲▼** until the desired date appears, then press **OK**.

On the Remote:
Press **△▽** until the desired date appears, then press **OK** or **▷**.

- Holding **CH ▲▼** or **△▽** changes the date in 15-day intervals.

■ Set year

On the front panel:
Press **CH▲▼** until the desired year appears, then press **OK** twice.

On the Remote:
Press **△▽** until the desired year appears, then press **OK** or **▷** twice.

■ Select D.S.T. mode

You can select either "ON" or "OFF".

ON— Adjustment will be made by the built-in clock itself.

OFF— Select when Daylight Saving Time does not apply to you.

On the front panel:
Press **CH▲▼** to select the desired setting.

On the Remote:
Press **△▽** to select the desired setting.

■ Start clock

Press **MENU** and normal screen appears.

To make corrections any time during the process

Press **OK** or **▷** repeatedly until the item you want to change blinks, then press **CH ▲▼** or **△▽**.

Tuner Setting

Turn on the VCR and the TV, and select the VCR channel 3 or 4 (or AV mode) on the TV.

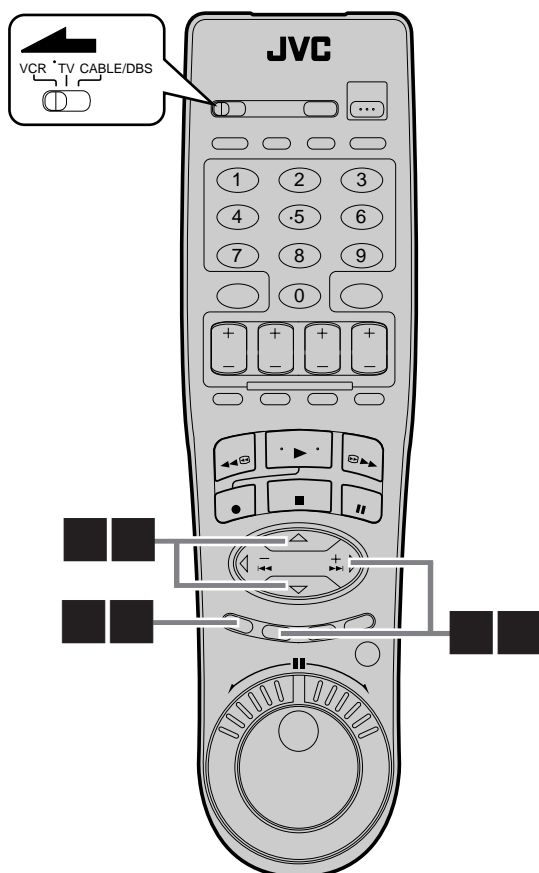
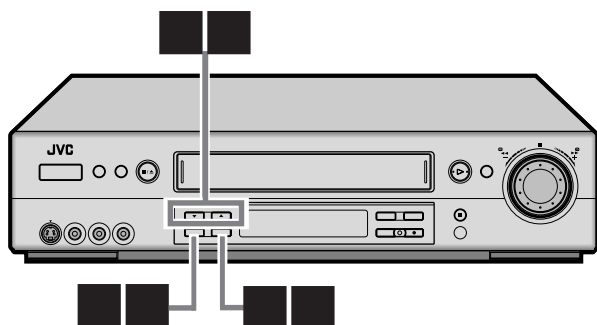

Setting channels automatically

— Auto Channel Set

Use Auto Channel Set only if channels have not been set correctly by the Plug & Play setting. If you want to add or delete channels, and want to use the ghost reduction function, use Manual Channel Set (pg. 14).

Access Main Menu screen

Press MENU.

Access Tuner Set screen

On the front panel:

Press CH▲▼ to move the highlight bar (arrow) to “TUNER SET”, then press OK.

On the Remote:

Press ▲▼ to move the highlight bar (arrow) to “TUNER SET”, then press OK or ▷.

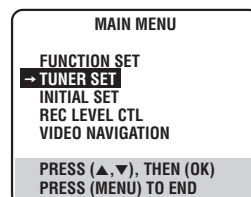

Perform Auto Channel Set

You can automatically set the receivable channels in your area in the order of their frequencies.

On the front panel:

Press CH▲▼ to move the highlight bar (arrow) to “AUTO CHANNEL SET”, then press OK.

On the Remote:

Press ▲▼ to move the highlight bar (arrow) to “AUTO CHANNEL SET”, then press OK or ▷.

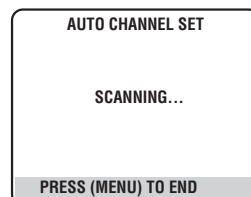
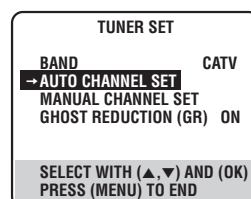

NOTES:

- When Auto Channel Set is complete, “SCAN COMPLETED” appears on screen.
- If the scan was unsuccessful, “SCAN COMPLETED—NO SIGNAL” appears on screen. Check the connections and start again.

Return to normal screen

Press MENU.

INFORMATION

The VCR selects the correct band (TV or CATV) automatically during Auto Channel Set. The selected band will be displayed on the right side of “BAND” on the Tuner Set screen.

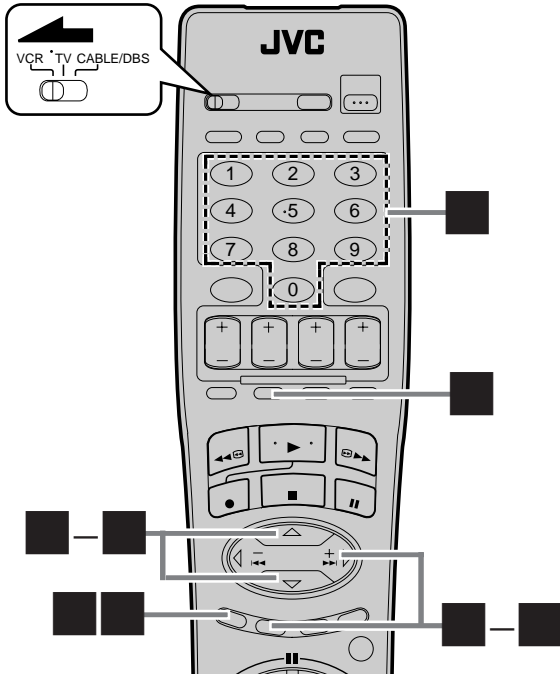
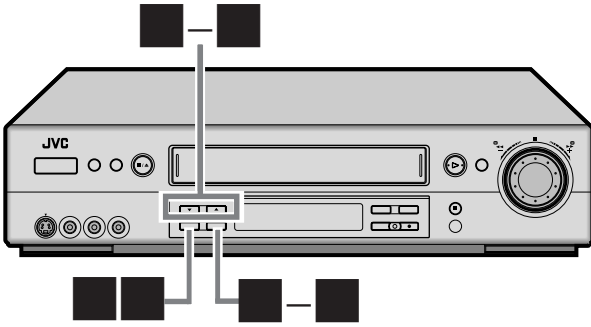

Setting channels manually

— Manual Channel Set

You can add the channels you want or delete the channels you do not want manually. You can also select the ghost reduction mode for each channel while adding the channels you want.

Access Main Menu screen

Press **MENU**.

Access Tuner Set screen

On the front panel:

Press **CH▲▼** to move the highlight bar (arrow) to “TUNER SET”, then press **OK**.

On the Remote:

Press **△▽** to move the highlight bar (arrow) to “TUNER SET”, then press **OK** or **▷**.

Access Manual Channel Set screen

On the front panel:

Press **CH▲▼** to move the highlight bar (arrow) to “MANUAL CHANNEL SET”, then press **OK**.

On the Remote:

Press **△▽** to move the highlight bar (arrow) to “MANUAL CHANNEL SET”, then press **OK** or **▷**.

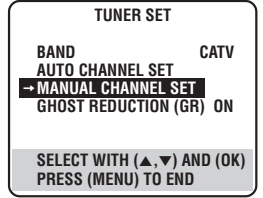

Add or skip desired channels

To add channels

On the Remote ONLY:

- 1 Press the **Number** keys to input a channel number you want to add.
- 2 Press **OK** or **▷** to set to “ADD”.
- 3 Press **SP/EP (//)** to select the desired ghost reduction mode if you want. (See also the next page.)

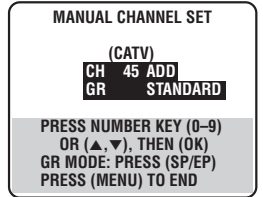
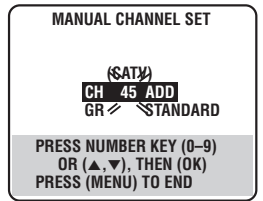

You have three choices:

STANDARD – Normally select this.

SOFT – Select when you prefer softer picture than when “STANDARD” is selected.

OFF – Select when neither “STANDARD” nor “SOFT” improves the picture.

- 4 Repeat 1 to 3 to add other channels.

To skip channels

On the front panel:

- 1 Press **CH▲▼** to select a channel number you want to skip.
- 2 Press **OK** to set to “SKIP”.
- 3 Repeat 1 and 2 to skip other channels.

On the Remote:

- 1 Press the **Number** keys or **△▽** to input a channel number you want to skip.
- 2 Press **OK** or **▷** to set to “SKIP”.
- 3 Repeat 1 and 2 to skip other channels.

Return to normal screen

Press **MENU**.

What is a "ghost"?

Double images of a TV program, or a "ghost", is a common problem with TV reception in urban areas. A broadcasting signal, reflected from some surfaces (building, mountain, etc.), arrives slightly later than the signals arriving directly from the TV station. This causes such ghosts as follows:

- Double images
- Faint images
- Distorted images
- Distorted colors
- Vertically jittered images



Setting ghost reduction

This VCR is equipped with the ghost reduction function. It reduces the ghosts using a GCR (Ghost Canceller Reference) signal sent from a TV station. The ghost reduction mode can be set for each channel independently and manually.

NOTES:

- Ghosts may not be reduced in the following cases:
 - The broadcasting signal does not have a GCR signal.
 - The antenna is not connected correctly.
 - There are too many ghosts.
 - The signal is reflecting from moving objects (airplane, etc.).
- The images on the screen may be distorted when tuning from one channel to another or the power is turned on while the ghost reduction function is activated.

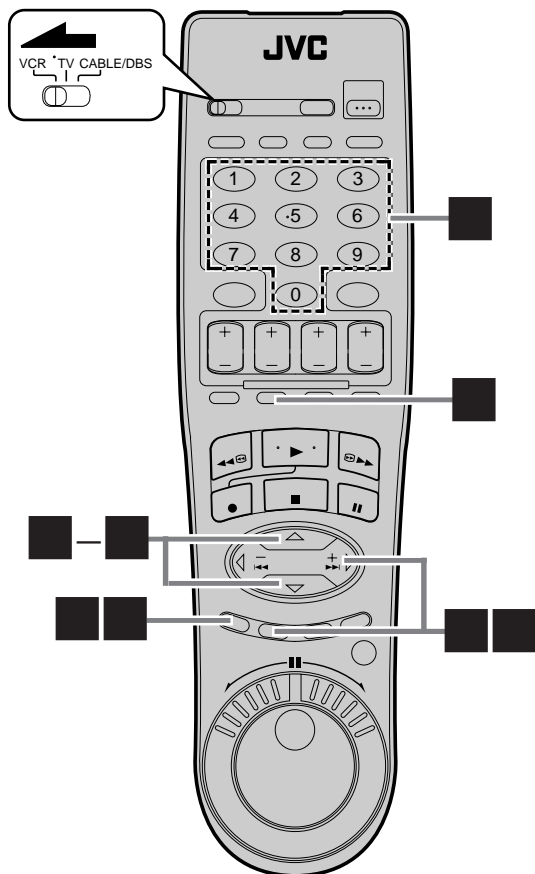
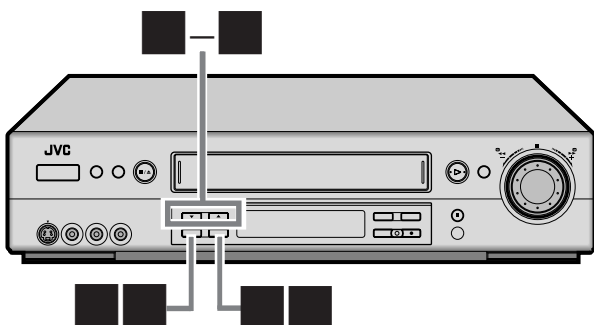

Access Main Menu screen

Press **MENU**.

Access Tuner Set screen

On the front panel:

Press **CH▲▼** to move the highlight bar (arrow) to "TUNER SET", then press **OK**.

On the Remote:

Press **△▽** to move the highlight bar (arrow) to "TUNER SET", then press **OK** or **▷**.

Access Manual Channel Set screen

On the front panel:

Press **CH▲▼** to move the highlight bar (arrow) to "MANUAL CHANNEL SET", then press **OK**.

On the Remote:

Press **△▽** to move the highlight bar (arrow) to "MANUAL CHANNEL SET", then press **OK** or **▷**.

Select a channel and set ghost reduction mode

On the Remote ONLY:

- 1 Press the **Number** keys or **△▽** to input a channel number.
- 2 Press **SP/EP (/ //)** to select the desired ghost reduction mode.

You have three choices:

- STANDARD** – Normally select this
- SOFT** – Select when you prefer softer picture than when "STANDARD" is selected.
- OFF** – Select when neither "STANDARD" nor "SOFT" improves the picture.

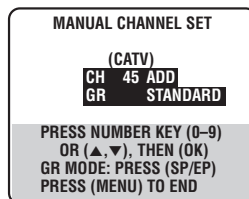

Return to normal screen

Press **MENU**.

Cable Box Control Setting

Suggested location

Place the cable box on top of the VCR. Attach the VCR's Controller to the top of the VCR with the Controller's transmitter pointed towards the cable box's remote sensor.

ATTENTION:

The Controller can also control a DBS receiver. If both a cable box and a DBS receiver are used, position the Controller so its signal reaches the remote sensors on both the cable box and DBS receiver.

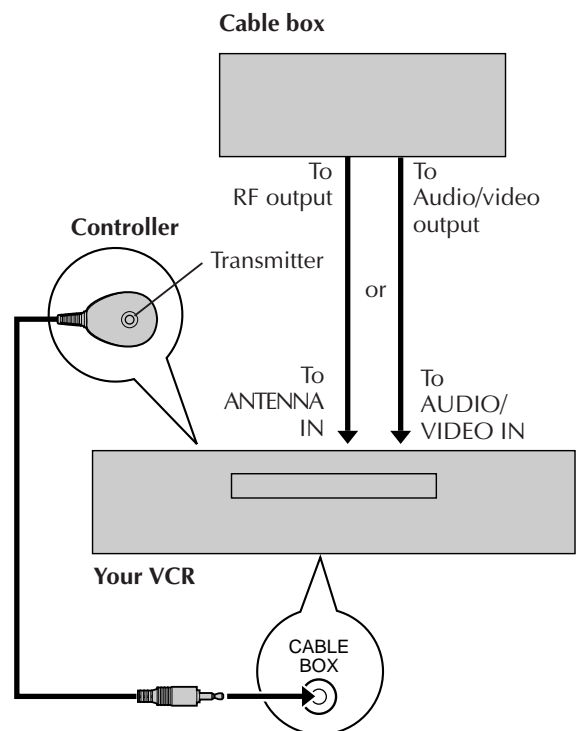
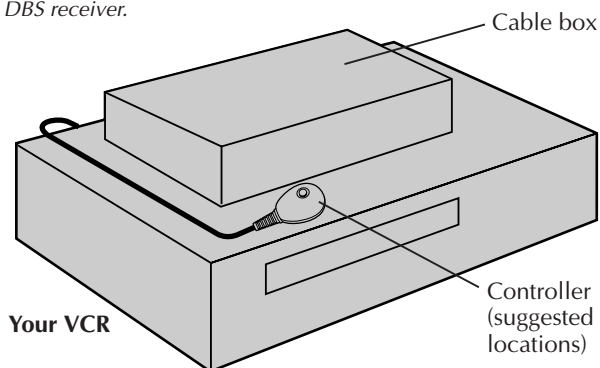

The following procedure is required if you receive your TV channels through a cable box (descrambler). The Controller allows the VCR to automatically switch the cable box channel during timer recording. The Controller is effective for recording broadcasts that have been programmed using VCR Plus+ (☞ pg. 38) or Express timer programming (☞ pg. 42).

Installing Controller

Situate Controller

Place the Controller so that its transmitter is facing the cable box's remote sensor.

- Make sure the path between the Controller and the cable box's remote sensor is not blocked.

Attach Controller

Fix securely using the adhesive strip attached on the back of the Controller.

Connect cable box to VCR

- **If your cable box does not have audio/video output connectors**

Connect the RF output terminal on the cable box to the ANTENNA IN terminal on the rear of your VCR.

- **If your cable box has audio/video output connectors**

Connect an audio/video cable between the AUDIO/VIDEO IN connectors on the rear of the VCR and the audio/video output connectors on the cable box.

NOTE:

When connecting your cable box, refer to its instruction manual.

Connect Controller to VCR

Connect the Controller to the CABLE BOX Controller connector on the rear panel.

How to control the cable box

This VCR has two separate methods to control your cable box.

- The VCR's wireless Remote can control your cable box. This eliminates the need for a separate cable box's Remote.
- The VCR's Controller can also control your cable box. This allows the VCR to change your cable box's channel number during timer recording.

Each method must be set up separately. To set up the VCR's Remote, refer to page 71. To set up the Controller, go to page 17.

Turn on the VCR and the TV, and select the VCR channel 3 or 4 (or AV mode) on the TV.

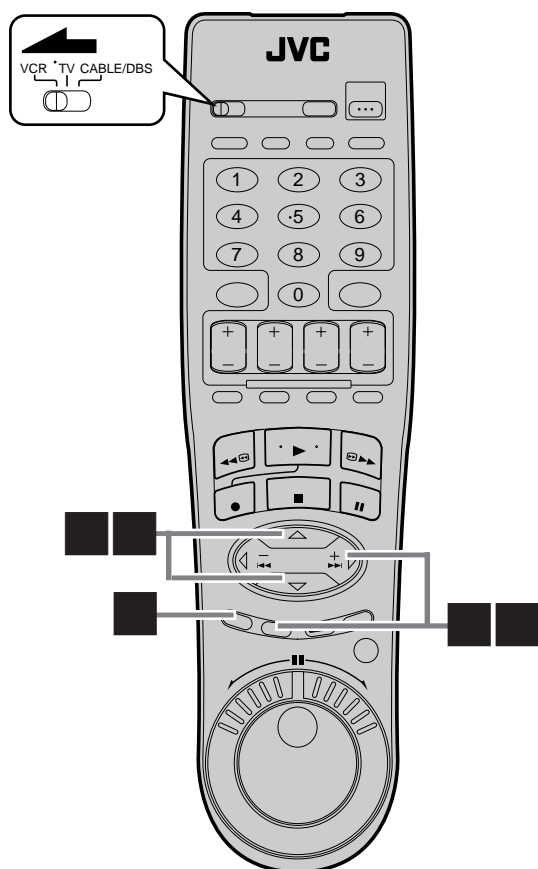
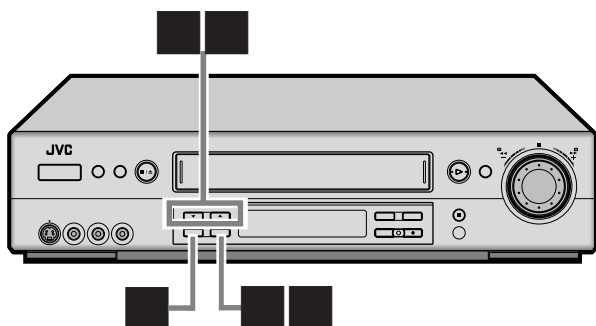

Setting cable box output channel & brand

After installation, set the cable box output's channel and its brand correctly; otherwise, the Controller cannot work correctly.

Turn on cable box

Select a channel other than channel 9 on your cable box.

Access Main Menu screen on VCR

Press **MENU**.

Access Initial Set screen

On the front panel:

Press **CH▲▼** to move the highlight bar (arrow) to "INITIAL SET", then press **OK**.

On the Remote:

Press **△▽** to move the highlight bar (arrow) to "INITIAL SET", then press **OK** or **▷**.

Access Cable Box Set screen

On the front panel:

Press **CH▲▼** to move the highlight bar (arrow) to "CABLE BOX SET", then press **OK**.

On the Remote:

Press **△▽** to move the highlight bar (arrow) to "CABLE BOX SET", then press **OK** or **▷**.

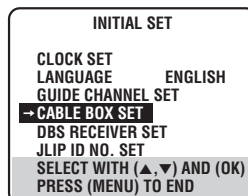

CONTINUED ON NEXT PAGE →

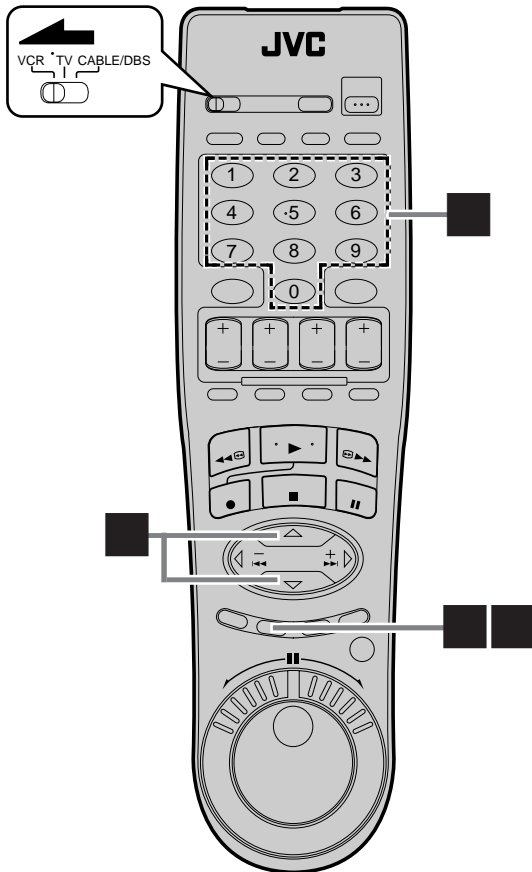
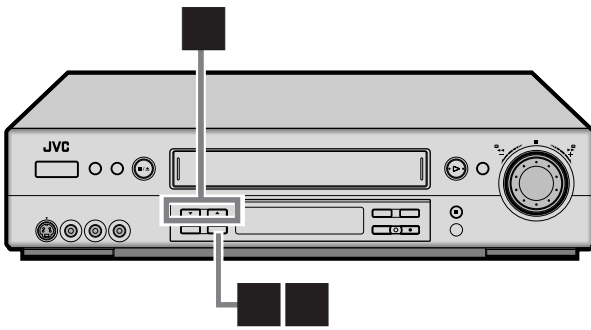

Select cable box output channel

Your selection depends on how your cable box is connected to your VCR.

- **If your cable box is connected to your VCR's ANTENNA IN terminal on the rear**

Press **CH ▲▼** on the front panel or **△▽** on the Remote until the channel number representing the cable box's output (CH2 – CH9) appears on the screen.

- **If your cable box is connected to your VCR's AUDIO/VIDEO IN connectors on the front panel**
- Press **CH ▲▼** on the front panel or **△▽** on the Remote until "ON F-1 (FRONT)" appears on the screen.

- **If your cable box is connected to your VCR's AUDIO/VIDEO IN connectors on the rear panel**
- Press **CH ▲▼** on the front panel or **△▽** on the Remote until "ON L-1 (REAR)" appears on the screen.

- **If you do not use a cable box**

Press **CH ▲▼** on the front panel or **△▽** on the Remote until "OFF" appears on the screen.

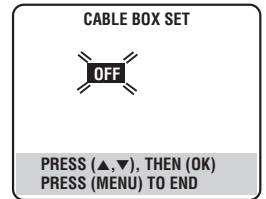

Access Cable Box Brand Set screen

Press **OK**.

Enter cable box brand

On the Remote ONLY:

Press the appropriate **Number** keys to enter the brand code from the list shown to the right, then press **OK**.

- **If the cable box's channel changes to 9, setting is complete**
- Press **OK** and "CABLE BOX CONTROL IS ON" appears on the screen for about 5 seconds, then it returns to the normal screen.

- **If the cable box's channel does not change to 9**

- ① Press **△▽** (or **CH ▲▼** on the front panel) to move the highlight bar (arrow) to "NO".
- ② Press **OK**.
- ③ Repeat step ① until the cable box's channel changes to 9 by entering another code.
- ④ If the channel does not change after going through all the code numbers listed for your model of cable box, then try all the other numbers.

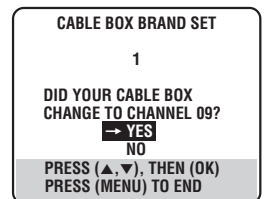
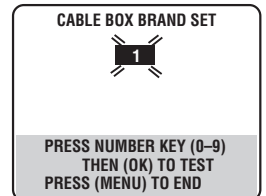

CABLE BOX BRAND LIST

BRAND	CODE
ARCHER	1, 5, 17
CABLETENNA	1, 17
CABLEVIEW	15, 16, 17, 21, 25
CITIZEN	15, 16, 17, 21, 25
CURTIS	2, 8
DIAMOND	1, 17
EASTERN	19
GC BRAND	15, 16, 17, 21, 25
GEMINI	15
GENERAL INSTRUMENTS	1, 4, 6, 11, 12, 15, 28
HAMLIN	10, 18, 19, 23
JASCO	15
JERROLD	1, 4, 6, 11, 12, 15, 28
NOVAVISION	2, 8
OAK	7, 20
PANASONIC	13, 14
PULSER	15, 16, 17, 21, 25
RCA	13, 14
REGAL	10, 18, 19, 23
REGENCY	19
REMBRANDT	1, 16, 17
SAMSUNG	5, 16, 24
SCIENTIFIC ATLANTA	2, 8
SIGMA	7, 20
SL MARX	5, 16, 17, 24, 25
SPRUCER	13, 14
STARGATE	5, 15, 16, 17, 21, 24, 25
TELEVIEW	5, 16, 24
TOCOM	1, 4, 16
UNIKA	1, 17
UNIVERSAL	16, 17, 25
VIDEOWAY	3, 9, 22
ZENITH	3, 9, 22

If the VCR's clock has not been set (with AUTO CLOCK set to ON)

"CABLE BOX USERS SET CLOCK MANUALLY" appears for about 5 seconds when you press **OK** in step ■, then the Clock Set screen appears.

Perform Manual Clock Set on page 12. If you press **MENU** after the clock has been set, the Cable Box Brand Set screen appears.

NOTES:

- The Controller may not work with all types of cable box.
- If your cable box does not respond to any code, you cannot use the Controller to change cable box channels. In this case, make sure to leave the cable box turned on and tuned to the proper channel before the scheduled start time of timer recording.
Contact your cable company about the possibility of exchanging your current cable box with the one compatible with your VCR.
- The VCR can only change the cable box channel through the Controller during timer recording.
- If your cable box cannot be operated with a remote control (because it has no remote sensor), you cannot use the Controller to change its channels. Make sure to leave the cable box turned on and tuned to the proper channel before the scheduled start time of timer recording.
- If the VCR's memory backup expires because of a power failure, set the cable box output channel and brand again.
- **For customers in U.S.A.:** If you are unable to set the Controller, contact JVC toll free at 1-800-252-5722.

DBS Receiver Control Setting

Suggested location

Place the DBS (Direct Broadcast Satellite) receiver on top of the VCR. Attach the VCR's Controller to the top of the VCR with the Controller's transmitter pointed towards the DBS receiver's remote sensor.

ATTENTION:

The Controller can also control a cable box. If both a DBS receiver and a cable box are used, position the Controller so its signal reaches the remote sensors on both the DBS receiver and cable box.

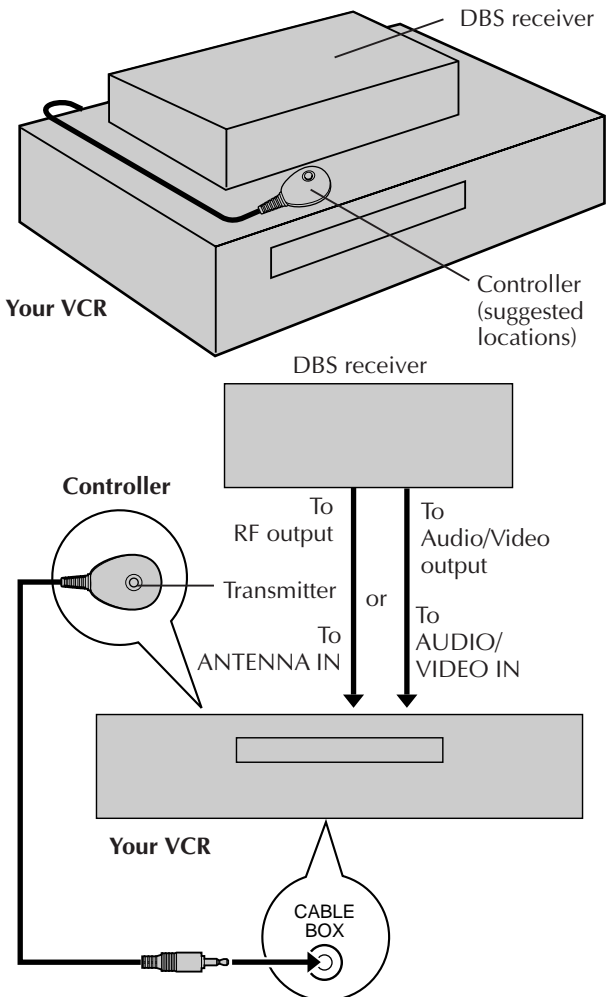

The following procedure is required if you receive satellite channels through a DBS (Direct Broadcast Satellite) receiver. The Controller allows the VCR to automatically switch the DBS receiver's channels during timer recording.

NOTES:

- The VCR can automatically change the DBS receiver channels using the Controller when the VCR has been programmed using Express timer programming (☞ pg. 42). Because satellite programming does not use PlusCode, the Controller cannot change the DBS receiver channels during VCR Plus+ timer recording. (You can also use "Satellite Auto Recording" (☞ pg. 61) if your DBS receiver is equipped with a timer.)
- If a cable box is also used, it is recommended that you connect the DBS receiver to your VCR's audio/video input connectors and the cable box to your VCR's antenna input terminal.

Installing Controller

Situate Controller

Place the Controller so that its transmitter is facing the DBS receiver's remote sensor.

- Make sure the path between the Controller and the DBS receiver's remote sensor is not blocked.

Attach Controller

Fix securely using the adhesive strip attached on the back of the Controller.

Connect DBS receiver to VCR

- **If your DBS receiver does not have audio/video output connectors**
Connect the RF output terminal on the DBS receiver to the ANTENNA IN terminal on the rear of your VCR.
- **If your DBS receiver has audio/video output connectors**
Connect an audio/video cable between the AUDIO/VIDEO IN connectors on the rear of the VCR and the audio/video output connectors on the DBS receiver.

NOTE:

When connecting your DBS receiver, refer to its instruction manual.

Connect Controller to VCR

Connect the Controller to the CABLE BOX Controller connector on the rear panel.

How to control the DBS receiver

This VCR has two separate methods to control your DBS receiver.

- The VCR's wireless Remote can control your DBS receiver. This eliminates the need for a separate DBS receiver's Remote.
- The VCR's Controller can also control your DBS receiver. This allows the VCR to change your DBS receiver's channel number during timer-recording.

Each method must be set up separately. To set up the VCR's Remote, refer to page 72. To set up the Controller, go to page 21.

Turn on the VCR and the TV, and select the VCR channel 3 or 4 (or AV mode) on the TV.

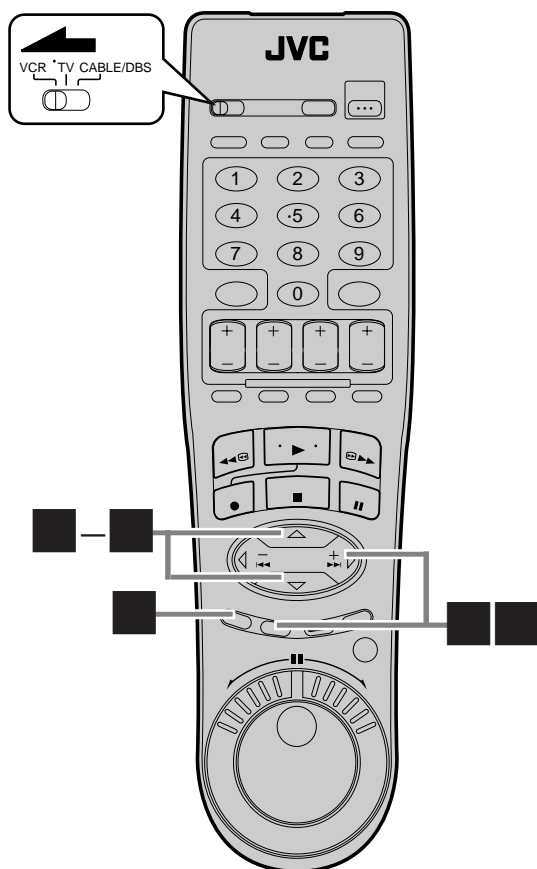
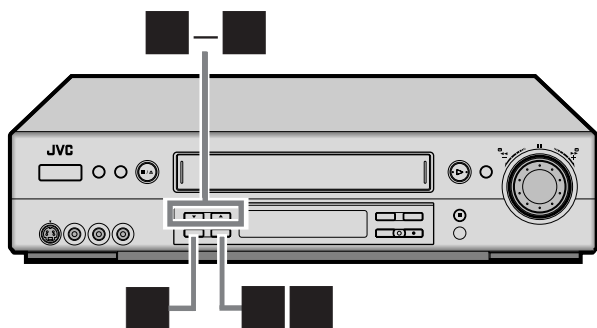

Setting DBS receiver output channel & brand

After installation, set the DBS receiver's output channel and its brand correctly; otherwise, the Controller cannot work correctly.

Turn on DBS receiver

Select a channel other than channel 55, 100 or 205 on your DBS receiver.

Access Main Menu screen on VCR

Press **MENU**.

Access Initial Set screen

On the front panel:

Press **CH▲▼** to move the highlight bar (arrow) to "INITIAL SET", then press **OK**.

On the Remote:

Press **△▽** to move the highlight bar (arrow) to "INITIAL SET", then press **OK** or **▷**.

Access DBS Receiver Set screen

On the front panel:

Press **CH▲▼** to move the highlight bar (arrow) to "DBS RECEIVER SET", then press **OK**.

On the Remote:

Press **△▽** to move the highlight bar (arrow) to "DBS RECEIVER SET", then press **OK** or **▷**.

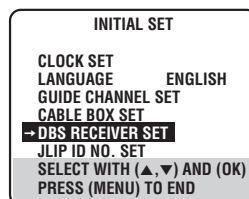

Select DBS receiver output channel

Your selection depends on how your DBS receiver is connected to your VCR.

- If your DBS receiver is connected to your VCR's ANTENNA IN terminal on the rear**
 Press **CH ▲▼** on the front panel or **△▽** on the Remote until the channel number representing the DBS receiver's output (CH3 or CH4) appears on the screen.
- If your DBS receiver is connected to your VCR's AUDIO/VIDEO IN connectors on the front panel**
 Press **CH ▲▼** on the front panel or **△▽** on the Remote until "ON F-1 (FRONT)" appears on the screen.
- If your DBS receiver is connected to your VCR's AUDIO/VIDEO IN connectors on the rear panel**
 Press **CH ▲▼** on the front panel or **△▽** on the Remote until "ON L-1 (REAR)" appears on the screen.
- If you do not use a DBS receiver**
 Press **CH ▲▼** on the front panel or **△▽** on the Remote until "OFF" appears on the screen.



CONTINUED ON NEXT PAGE →

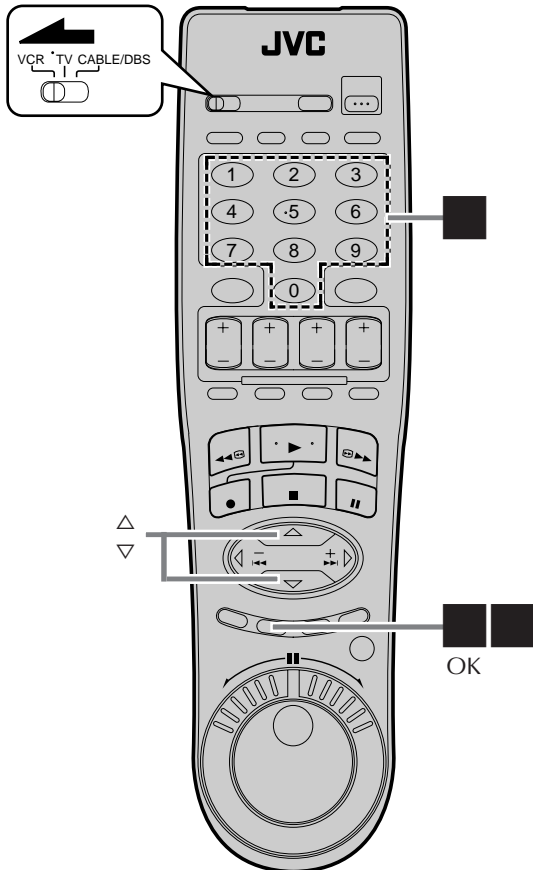
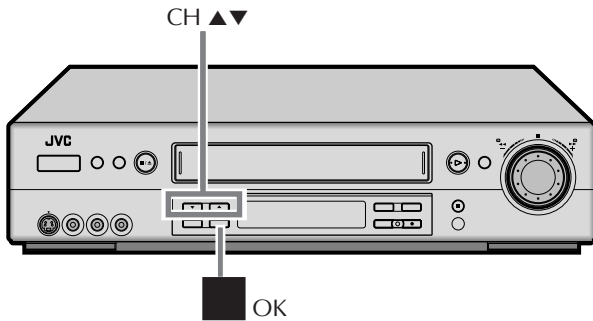

Access DBS Receiver Brand Set screen

Press **OK**.

Enter DBS Receiver's brand

On the Remote ONLY:

Press the appropriate **Number** keys to enter the brand code from the following list, then press **OK**.

The program currently received through the DBS receiver appears for about 10 seconds.



BRAND	CODE
JVC (DISH Network)	51
ECHOSTAR (DISH Network)	51
PRIMESTAR	50
SONY (DSS)	41
RCA (DSS)	40

- If the DBS receiver's channel changes to the channel listed below for your brand, setting is complete

JVC → 100
 ECHOSTAR → 100
 PRIMESTAR → 55
 SONY → 205
 RCA → 205

Press **OK** and "DBS RECEIVER CONTROL IS ON" appears on the screen for about 5 seconds, then it returns to the normal screen.

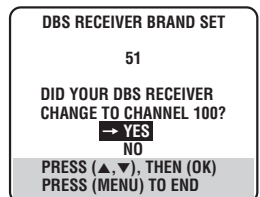

- If the DBS receiver's channel does not change as shown above

- ① Press Δ ∇ (or **CH ▲▼** on the front panel) to move the highlight bar (arrow) to "NO".
- ② Press **OK**.
- ③ Re-enter the correct code.

NOTES:

- The Controller may not work with all types of DBS receiver.
- If your DBS receiver does not respond to the code, you cannot use the Controller to change satellite channels. In this case, make sure to leave the DBS receiver turned on and tuned to the proper channel before the scheduled start time of timer recording. In addition, if your DBS receiver is equipped with a timer, you can also use "Satellite Auto Recording" (see pg. 61).
- The VCR can only change the satellite channel through the Controller during timer recording.
- If your DBS receiver cannot be operated with a remote control (because it has no remote sensor), you cannot use the Controller to change its channels. Make sure to leave the DBS receiver turned on and tuned to the proper channel before the scheduled start time of timer recording.
- **For customers in U.S.A.:** If you are unable to set the Controller, contact JVC toll free at 1-800-252-5722.

Basic Playback

Turn on the VCR and the TV, and select the VCR channel 3 or 4 (or AV mode) on the TV.

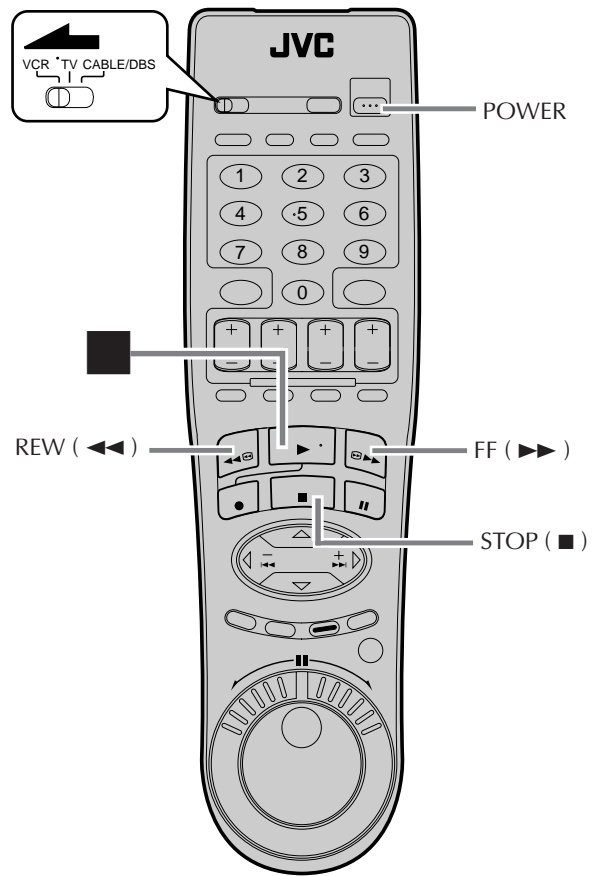
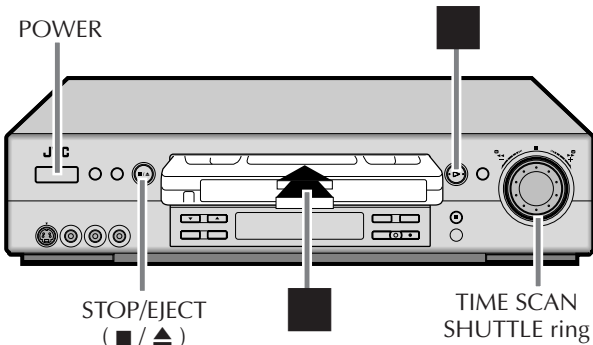

This VCR can check the tape condition during playback (and recording), and realizes the best possible pictures.

- When you play back a tape recorded on this VCR, you can use the Video Navigation function (☞ pg. 46).

Load a cassette

Make sure the window side is up, the rear label side is facing you and the arrow on the front of the cassette is pointing towards the VCR. Do not apply too much pressure when inserting.

- The VCR turns on automatically.
- The counter is automatically reset to "0:00:00".
- The tape will run for a few seconds while the VCR searches for the tape number. If the tape number is found, it will be shown on the TV screen if "SUPERIMPOSE" is set to "ON." (☞ pg. 56, 57)
- If the cassette's record safety tab has been removed, playback begins automatically.

Start playback

Press **PLAY** (▶).

- Tape speed (SP or EP) is automatically detected.
- The S-VHS indicator lights up when you play back a tape recorded in S-VHS mode or in S-VHS ET mode (☞ pg. 31).
- If "VIDEO CALIBRATION" is set to "ON" (default setting: ☞ pg. 57), "VIDEO CALIBRATION" appears on the screen, and this VCR checks the tape condition during automatic tracking.

To stop playback

Press **STOP** (■) on the Remote or **STOP/EJECT** (■/▲) on the front panel.

To rewind the tape (when it is not running)

Press **REW** (◀◀) (or turn the **TIME SCAN SHUTTLE** ring on the front panel to the left).

To fast-forward (when it is not running)

Press **FF** (▶▶) (or turn the **TIME SCAN SHUTTLE** ring on the front panel to the right).

To eject the tape

Press **STOP/EJECT** (■/▲) on the front panel when the tape is not running.

- You can also eject the cassette when the VCR is turned off.

To turn off the VCR

Press **POWER**.

NOTE:

When you use the Video Navigation function, operate the VCR only after the tape number is detected; otherwise, you cannot use the Video Navigation function.

Basic Playback Features

Turn on the VCR and the TV, and select the VCR channel 3 or 4 (or AV mode) on the TV.

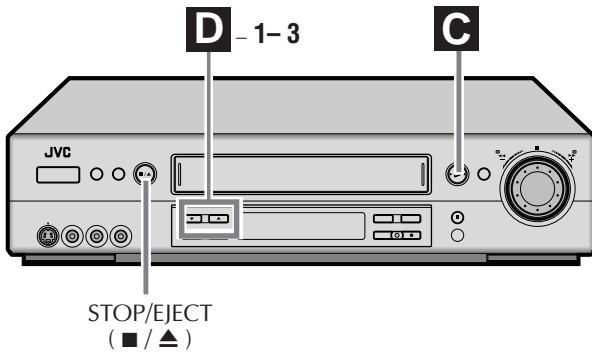

A Changing display information

Press **DISPLAY** during playback.

Each time you press the button, the front display panel shows the time counter, tape remaining time and the clock time in sequence.

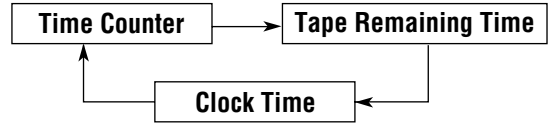

- To display the VCR status including the time counter and the clock time on the TV screen, see “Showing on-screen display” (pg. 31).
- “COUNT” appears on the screen when the time counter is shown. “REMAIN” appears on the screen when the tape remaining time is shown.
- When the tape remaining time appears, “▶” also lights on the front display panel.
- The tape remaining time is calculated based on the tape speed (SP or EP) being used. The indicated remaining time is only an estimate.

To reset the time counter, press **C. RESET** on the Remote. The counter reading becomes “0:00:00”. It is also reset when a tape is inserted.

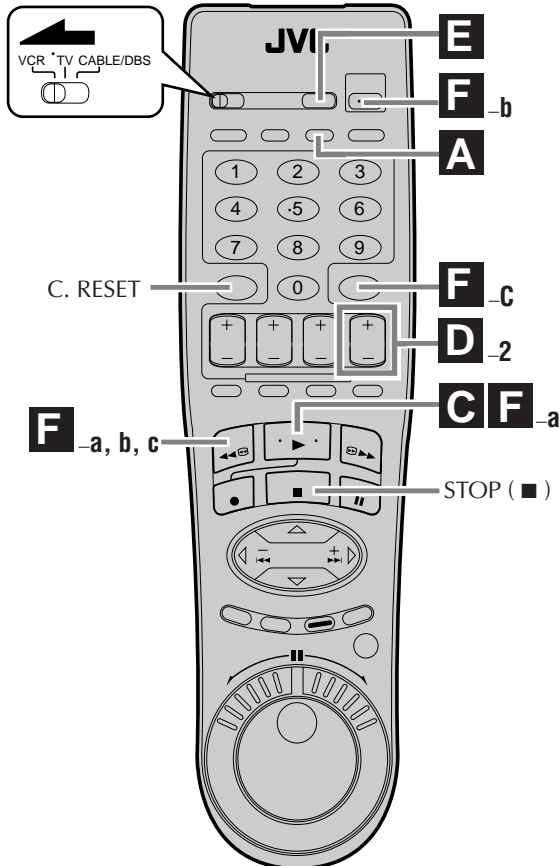

B Checking tape position

The tape position indicator appears on the screen in the following cases:

- When you change the VCR operation mode from the stop mode to fast forward or rewind mode.
- When you perform an Index Search (pg. 26) or Instant Review (pg. 26).

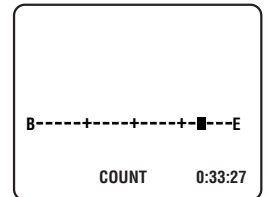

The position of “■” in relation to “B” (Beginning) or “E” (End) shows you where you are on the tape.

NOTES:

- “SUPERIMPOSE” must be set to “ON”, or the indicator will not appear (pg. 56, 57).
- It may take a few seconds for the tape position indicator to be displayed.

C Playing back tape repeatedly

— Repeat Play

You can play back a tape repeatedly (100 times).

While playing back a tape, press and hold **PLAY** (▶) for more than 5 seconds.

The play indicator (▷) on the front display panel starts flashing slowly, and a tape will be played back 100 times.

To stop playback, press **STOP** (■) on the Remote or **STOP/EJECT** (■/▲) on the front panel.

D Adjusting tracking condition

— Tracking Adjustments

Automatic tracking adjustment

This VCR automatically adjusts the tracking condition. Whenever you insert a tape and start playback, automatic tracking starts working and continuously analyzes the signal to enable optimum picture quality during playback.

Manual tracking adjustment

If automatic tracking cannot eliminate noises well during playback, use the manual tracking following the procedures below.

- You can also use the manual tracking during slow motion playback (☞ pg. 36).

1 Activate manual tracking

Press **CH** ▲ and ▼ on the front panel at the same time during playback.

2 Eliminate the noises on the TV screen.

Press **CH** ▲ and ▼ (or **CH** + and – on the Remote).

- Press it briefly for a fine adjustment, or press and hold for a coarse adjustment. Watch the screen and continue adjustment until optimum picture and sound quality are achieved.

3 Reactivate automatic tracking

Press **CH** ▲ and ▼ on the front panel at the same time. The automatic tracking becomes active again.

E Selecting monitor sound

— Audio Monitor

You can select the desired monitor sound.

While playing back a tape on which stereo sound or SAP sound is recorded, press **A. MONITOR** on the Remote.

Each time you press the button, sound changes as follows:

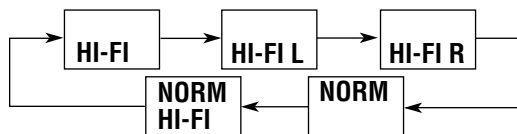

HI-FI: Normally select this.

Hi-Fi sound is played back.

HI-FI L: Sound on the left Hi-Fi channel is played back.

HI-FI R: Sound on the right Hi-Fi channel is played back.

NORM: Sound on the normal track is played back.

NORM HI-FI:

Both sounds on the Hi-Fi track and normal track are mixed and played back.

NOTES:

- The above indication appears when "SUPERIMPOSE" is set to "ON" (☞ pg. 56, 57), though the monitor sound changes in sequence.
- If the tape being played back has no Hi-Fi sound track, the normal sound track will be heard regardless of this setting.
- If RF connection (☞ pg. 7) is used for viewing pictures on the TV, sound will be monaural even though you select "HI-FI".
- You can also use the menu to select your desired monitor sound. (☞ pg. 59)

F Automatic operations after rewinding — Next Function Memory

The Next Function Memory "tells" the VCR what to do after rewinding is complete.

- Ensure that the VCR is in stop mode.

a- For Automatic Playback Start

Press **REW** (◀◀), then press **PLAY** (▶) within 2 seconds.

b- For Automatic Power Off

Press **REW** (◀◀), then press **POWER** within 2 seconds.

c- For Automatic Timer Standby

Press **REW** (◀◀), then press **TIMER** within 2 seconds.

NOTE:

It is not possible to select the Automatic Timer Standby function if the cassette's record safety tab is removed.

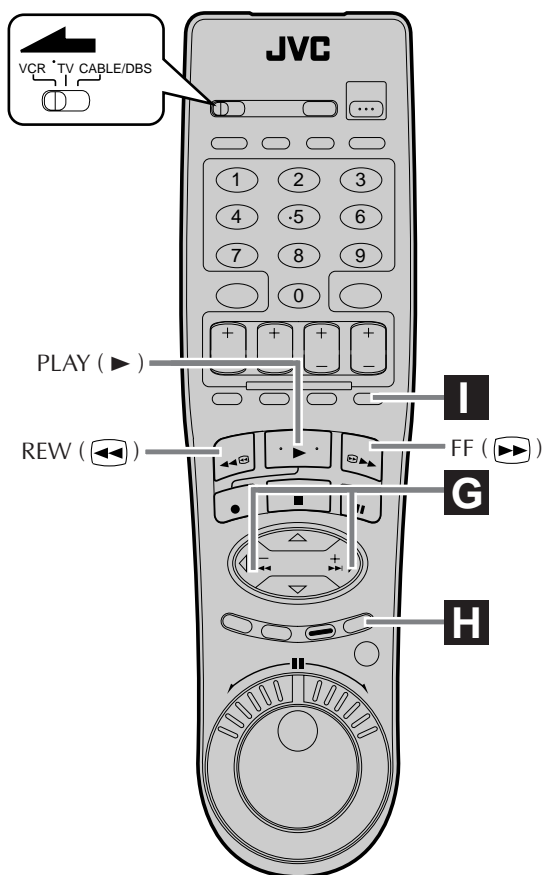
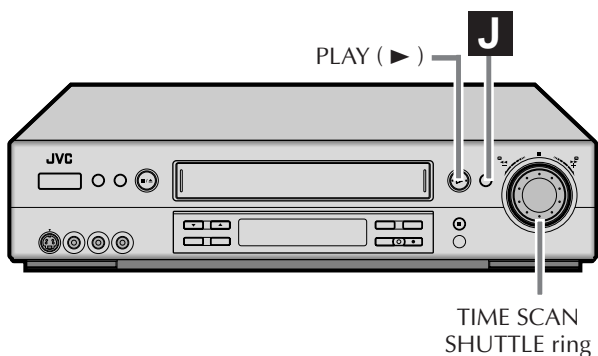

G Locating beginning of recordings — Index Search

Index codes are placed on the tape at the beginning of each recording when recording on this VCR. You can find and automatically play back from the beginning of any recording using the Index Search function.

1 Start search

While the tape is not running, press ◀◀ or ▶▶ on the Remote.

2 Access distant code

To access a recording of 2 to 9 index codes away, press ◀◀ or ▶▶ repeatedly until the correct number is displayed on the screen (only if "SUPERIMPOSE" is set to "ON"; see pg. 56, 57). Playback begins automatically when the desired recording is located.

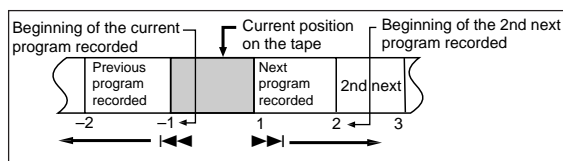

- If you want to find the very beginning of the desired program, press **REW** (◀◀) or **FF** (▶▶) on the Remote or turn the **TIME SCAN SHUTTLE** ring on the front panel after playback starts.

NOTE:

An index code is not placed on the tape when recording is resumed from recording pause.

H Locating beginning of timer recordings — Instant Review

At the press of a button, you can turn on the VCR, rewind the tape and begin to view the most recent timer-recorded program.

Press REVIEW on the Remote after ensuring that the VCR is in the timer recording standby mode.

- The VCR turns on, and rewinds to the index code indicating the beginning of the last timer-recorded program, then begins playback automatically.
- You can access a program of 2 to 9 index codes away from the current position on the tape. If, for example, you have 5 programs recorded and you want to watch the third one, press **REVIEW** three times.
- If you want to find the very beginning of the desired program, press **REW** (◀◀) or **FF** (▶▶) on the Remote or turn the **TIME SCAN SHUTTLE** ring on the front panel after playback starts.
- If the tape is already rewound when **REVIEW** is pressed, it will play the tape from the beginning. It will not fast-forward to an index code.
- The Instant Review function will also operate if the VCR is turned on.

I Skipping unwanted portions

— Skip Search

You can skip over (view at high speed) unwanted portions of the tape.

Press SKIP SEARCH on the Remote once to 4 times during playback.

Each press initiates a 30-second period of high speed playback (up to 2 minutes). When the specified portion of the tape is skipped, normal playback resumes automatically.

To return to normal playback during Skip Search, press PLAY (▶).

J Adjusting picture condition

— Digital TBC/NR

The Digital TBC/NR (Time Base Corrector / Noise Reduction) function removes jitter from fluctuating video signals to deliver a stable picture even with old tapes and rental tapes. The Digital R3 function which cuts noise and reproduces clear pictures is also linked to this function.

We recommend that you use the Digital TBC/NR function when...

- playing back a tape recorded on a camcorder.
- playing back a tape repeatedly used.
- using this VCR as the player for editing.

Press DIGITAL TBC/NR on the front panel so that the DIGITAL TBC/NR lamp lights up.

Each time you press the button, this function turns on and off.

NOTES:

- If you play back a tape recorded under poor TV reception condition, the picture may happen to become more stable with Digital TBC/NR activated.
- If you play back a tape on which certain types of signals (using a PC or some character generators) have been recorded with Digital TBC/NR activated, the playback picture may be distorted. In this case, deactivate Digital TBC/NR.
- Digital TBC/NR and Video Stabilizer (☞ pg. 58) cannot be used at the same time; if you turn on Digital TBC/NR when "VIDEO STABILIZER" is set to "ON", Video Stabilizer will be automatically turned "OFF". Make sure Digital TBC/NR is deactivated when you want to use Video Stabilizer.

Other Useful functions for playback

You can also use the following functions for playback.

- **Video Calibration** (☞ pg. 57)

When this function is set to "ON", this VCR checks the condition of the tape in use during playback and recording, and compensates to provide the highest-possible pictures.

- **Picture Control** (☞ pg. 57)

This function helps you to adjust the playback picture quality according to your preference.

- **Digital R3** (☞ pg. 58)

This function applies edge correction to the luminance signal to enhance details and provides clear pictures.

- **Video Stabilizer** (☞ pg. 58)

You can automatically correct vertical vibrations in the picture when playing back unstable recordings made on another VCR.

Clean the video heads using a dry cleaning cassette — TCL-2UX — when:

- Rough, poor picture appears while a tape is played back.
- The picture is unclear or no picture appears.
- "USE CLEANING CASSETTE" appears on the screen (only with "SUPERIMPOSE" set to "ON": ☞ pg. 56, 57.)

Basic Recording

Turn on the VCR and the TV, and select the VCR channel 3 or 4 (or AV mode) on the TV.

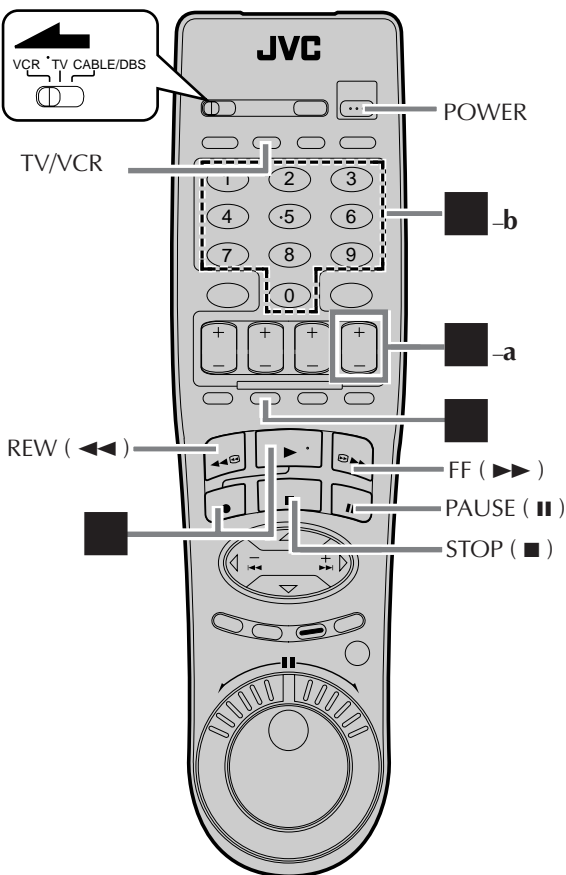
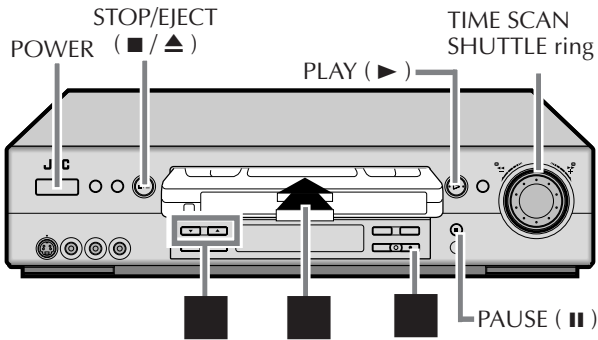

This VCR can check the tape condition during recording (and playback), and realizes the best possible pictures.

In addition, this VCR is equipped with the Video Navigation function, which allows you to quickly locate the programs you have recorded on a tape. When recording on this VCR, the tapes are automatically numbered so that every tape recorded on this VCR has a different tape number. With this function, the program information such as recording date, start time, channel number, and recording speed are also automatically stored in the VCR's memory.

- For the Video Navigation function, see page 46. To memorize the recording date and start time for the Video Navigation function, the date and clock must be set correctly.

Load a cassette

Make sure the record safety tab is intact. If not, cover the hole with adhesive tape before inserting the cassette.

Select recording channel

On the front panel:

Press **CH▲▼**.

On the Remote:

a- Press **CH +** or **-**,
or

b- Press the **Number** keys.

- If you connect the TV and the VCR only using the RF connection, press **TV/VCR** on the Remote so that the VCR mode indicator lights on the front display panel, to view the program to be recorded.

Set tape speed

Press **SP/EP (///)** to set the recording speed.

Start recording

On the front panel:

Press **REC (●)**.

On the Remote:

While holding **REC (●)**, press **PLAY (▶)**.

- If "VIDEO CALIBRATION" is set to "ON" (default setting: pg. 57), this VCR checks the tape condition for about seven seconds, then starts recording. This means that the first seven seconds of the program will not be recorded. If this is inconvenient for you, follow the steps below:
 - 1 Press **REC (●)** and **PAUSE (||)** to start Video Calibration.
 - 2 Then press **PLAY (▶)** to start recording after Video Calibration is complete.

To pause recording

Press **PAUSE** (■). To resume recording, press **PLAY** (▶).

To stop recording

Press **STOP** (■) on the Remote or **STOP/EJECT** (■ / ▲) on the front panel.

To rewind the tape (when it is not running)

Press **REW** (◀) (or turn the **TIME SCAN SHUTTLE** ring on the front panel to the left).

To fast-forward the tape (when it is not running)

Press **FF** (▶) (or turn the **TIME SCAN SHUTTLE** ring on the front panel to the right).

To eject the tape

Press **STOP/EJECT** (■ / ▲) on the front panel when the tape is not running.

- You can also eject the cassette when the VCR is turned off.

To turn off the VCR

Press **POWER**.

NOTE:

If "MEMORY FULL" appears on the display when you start recording, the VCR's memory for the Video Navigation function is full. This is not related to actual recording, so you can finish recording normally, but the Video Navigation information such as recording date, start time, end time, and channel number will not be stored in memory.

It may be unlawful to record or play back copyrighted material without the consent of the copyright owner.

Basic Recording Features

Turn on the VCR and the TV, and select the VCR channel 3 or 4 (or AV mode) on the TV.

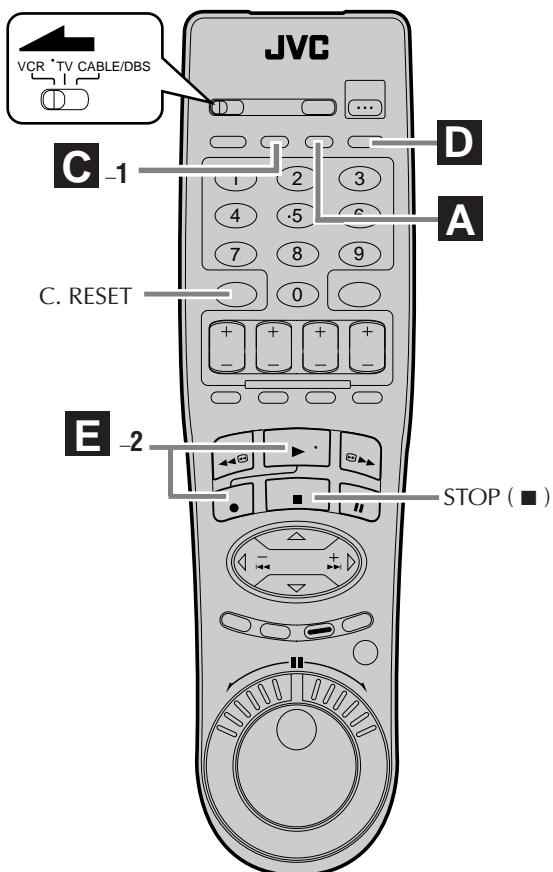
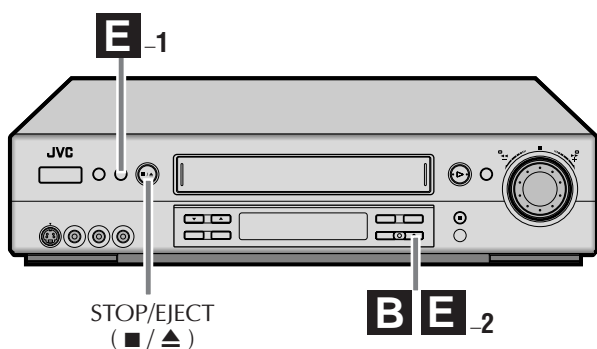

A Changing display information

Press **DISPLAY** during recording or recording pause. Each time you press the button, the front display panel shows the time counter, tape remaining time, channel number, and the clock time in sequence.

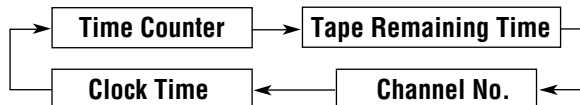

- To display the VCR status including the time counter and the clock time on the TV screen, see “Showing on-screen display” (pg. 31).
- “COUNT” appears on the screen when the time counter is shown. “REMAIN” appears on the screen when the tape remaining time is shown.
- When the tape remaining time appears, “▶” also lights on the front display panel.
- The tape remaining time is calculated based on the tape speed (SP or EP) being used. The indicated remaining time is only an estimate.

To reset the time counter, press **C. RESET** on the Remote. The counter reading becomes “0:00:00”. It is also reset when a tape is inserted.

B Specifying recording length

— Instant Timer Recording (ITR)

You can easily specify the recording length from 30 minutes to 6 hours and the VCR shuts off after recording is finished.

During recording, press REC (●) on the front panel repeatedly until the recording length you want appears on the front display panel.

The ◯ (record) indicator starts flashing. Each time you press the button, recording length increases in 30-minute intervals (up to 6 hours).

To cancel an ITR, press **STOP (■)** on the Remote or **STOP/EJECT (■/▲)** on the front panel.

C Watching one program while recording another

1 Engage TV mode

During recording...

- If you connect the TV and the VCR only using the RF connection (☞ pg. 7) to view pictures from the VCR

Press **TV/VCR** on the Remote so that VCR mode indicator goes off from the front display panel. (The TV broadcast being recorded disappears.)

- If you are using the AV connection (☞ pg. 7) to view pictures from the VCR, change the TV's input mode from AV to TV.

2 Select channel for viewing

Select the channel you want to watch, on the TV.

D Showing on-screen display

When "SUPERIMPOSE" is set to "ON" (☞ pg. 56, 57), you can see the current VCR status on the TV screen.

- For more detailed information about the on-screen display, see page 80.

1 Display VCR status on TV screen

During recording or recording pause, press

OSD on the Remote.

All indications corresponding to the current VCR status are displayed for 5 seconds.

The time counter remains on the screen indicating the elapsed time.

- The indications are not recorded.

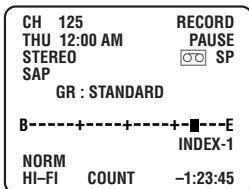

2 Exit on-screen display

Press **OSD** again.

NOTES:

- If the VCR is in recording pause mode, "RECORD/PAUSE" is always displayed.
- The VCR status can be also displayed during playback.

E Recording on VHS tapes with S-VHS quality — Super VHS ET

This function allows you to record on VHS tapes with S-VHS picture quality. Tapes recorded using this function can be played back only on a VCR equipped with the S-VHS ET function.

- You can activate this function only before you start recording on a VHS tape.
- Before recording, make sure "VIDEO CALIBRATION" is set to "ON." (☞ pg. 57)

1 Select S-VHS ET mode

Press **S-VHS ET** on the front panel. The S-VHS ET lamp lights up.

- The S-VHS indicator lights on the front display panel.
- To disengage the S-VHS ET mode, press **S-VHS ET** again. The lamp goes off.

2 Start recording

On the front panel:

Press **REC** (●).

On the Remote:

While holding **REC** (●), press **PLAY** (▶).

NOTES:

- You cannot activate the S-VHS ET function...
 - while recording is in progress.
 - while timer-recording or Instant Timer Recording (☞ p.30) is in progress.
 - while Video Calibration (☞ p.57) is in progress.
- S-VHS ET does not work with S-VHS tapes.
- To keep the highest quality recording and playback pictures over a long period of time, S-VHS recording on S-VHS tapes is recommended.
- Use of high grade tapes are recommended for S-VHS ET recordings.

On some tapes, picture quality will not improve even if the S-VHS ET function is used. Check the recording quality before you start important recordings.
- You can play back S-VHS ET recordings on most of S-VHS VCRs and of VHS VCRs equipped with SQPB (S-VHS QUASI PLAYBACK) function. (Notice some VCRs are not compatible with this function.)
- While playing back a tape recorded with this function, noise may appear. (If playback picture becomes blurred or interrupted, use a cleaning cassette.)
- During special effect playback (☞ pg. 34), noise may appear. If special effect playback is performed frequently on a tape recorded with this function, the tape may be damaged and picture may be deteriorated

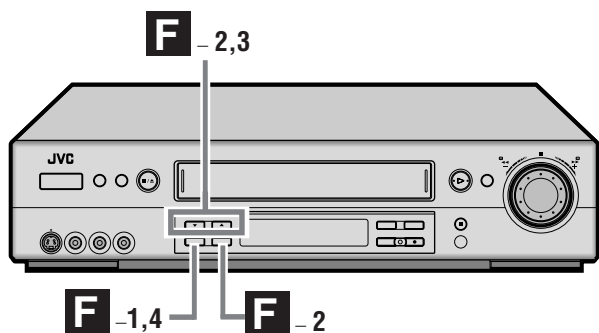

F Adjusting recording level

You can adjust the audio recording level manually.

1 Access Main Menu screen

Press **MENU**.

2 Select Recording Level Control screen

On the front panel:

Press **CH▲▼** to move the highlight bar (arrow) to "REC LEVEL CTL", then press **OK**.

On the Remote:

Press **Δ∇** to move the highlight bar (arrow) to "REC LEVEL CTL", then press **OK** or **▷**.

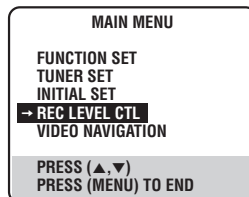

3 Adjust recording level

On the front panel:

Press **CH▲▼** to adjust the recording level.

On the Remote:

Press **Δ∇** to adjust the recording level.

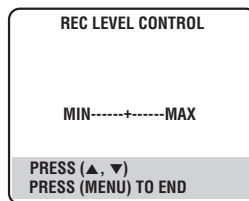

- Pressing the button briefly for 5 times in succession changes the recording level by one step on the level scale on the TV screen. To adjust the audio levels faster, press and hold the button.
- Adjust the recording level while watching the audio level meters on the front display panel. Set the level so that maximum volume causes the meters to vary between 0dB to 4dB.

4 Return to normal screen

Press **MENU**.

NOTES:

- Noise will increase if the recording level is too low, while distortion will increase if the level is too high.
- When you finished Audio recording, be sure to set the level back to its center position.

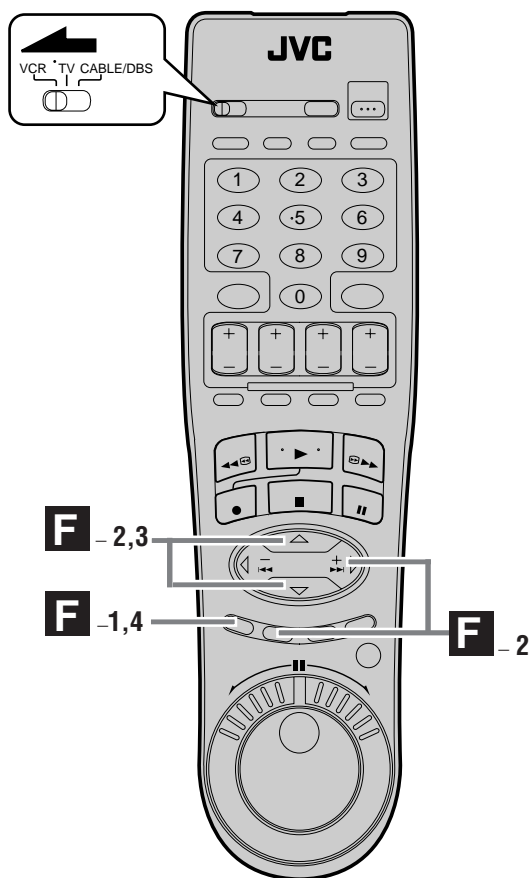

Other useful functions for recording

You can also use the following functions for recording.

- **Recording Resume Function**

If there is a power outage during recording (including Instant Timer Recording, timer recording, and Satellite Auto Recording), the recording will resume automatically when the power is restored to the VCR. (No setting is required for this function.)

- **Video Calibration** (☞ pg. 57)

When this function is set to "ON", this VCR checks the condition of the tape in use during playback and recording, and compensates to provide the highest-possible pictures.

- **Second Audio Recording** (☞ pg. 58)

This VCR's built-in MTS decoder enables reception of Multichannel TV Sound broadcast.

To record a SAP program received, set "2ND AUDIO RECORD" to "ON" using the menu screen.

NOTES:

When the channel is changed on the VCR;

- *The "STEREO" indication appears on the screen for about 5 seconds if the program is a stereo broadcast.*
- *The "SAP" indication appears on the screen for about 5 seconds if the program is a SAP broadcast.*
- *Both indications appear when a stereo program is accompanied by SAP sound.*

- **S-VHS Recording Mode** (☞ pg. 59)

This VCR allows you to record on an S-VHS tape with VHS picture quality.

Accidental erasure prevention

To prevent accidental recording on a recorded cassette, remove its record safety tab.

To record on it later, cover the hole with adhesive tape.

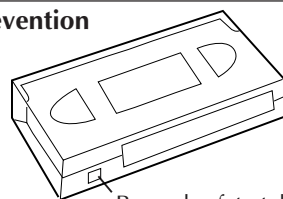

Record safety tab

Special Effect Playback

Turn on the VCR and the TV, and select the VCR channel 3 or 4 (or AV mode) on the TV.

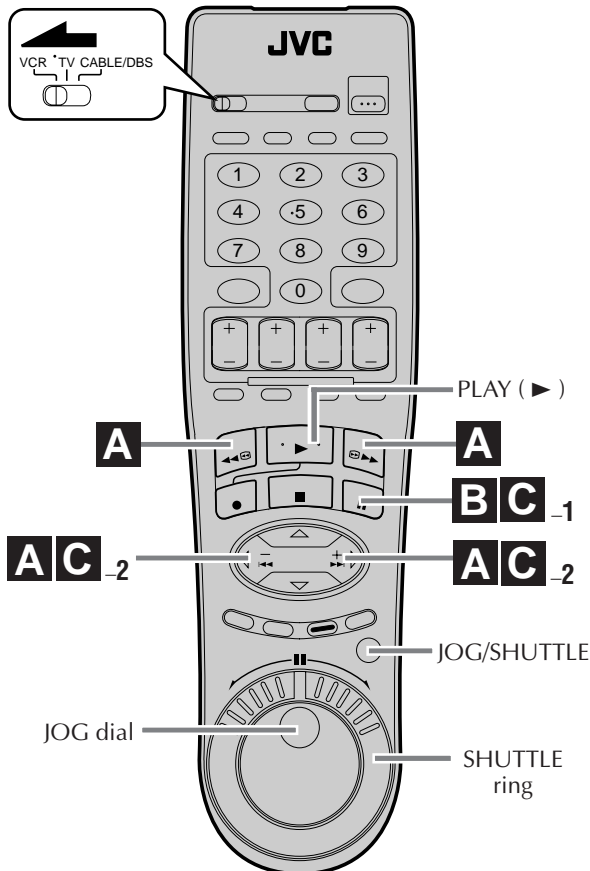
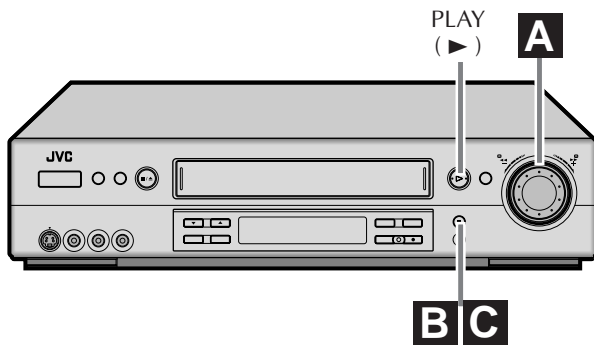

With this VCR, you can enjoy special effect playback such as high-speed search, variable-speed search, and still playback and so on.

During special effect playback, the TimeScan function enables this VCR to reproduce noiseless pictures and sounds. It is also possible not to reproduce sounds during picture search by setting "TIMESCAN AUDIO" to "OFF". (☞ pg. 60)

- For more about the TimeScan function, see page 37.

A Locating particular scene rapidly — Picture Search

■ High-Speed Picture Search:

Possible during normal playback or still picture playback.

You can rapidly locate a particular scene on the tape.

On the front panel:

To do forward picture search, turn the **TIME SCAN SHUTTLE** ring fully to the right. (Even if you release the ring, picture search continues.)

To do reverse picture search, turn the **TIME SCAN SHUTTLE** ring fully to the left. (Even if you release the ring, picture search continues.)

To resume normal playback, press **PLAY** (▶).

On the Remote:

To do forward picture search, press **FF** (▶▶).

To do reverse picture search, press **REW** (◀◀).

- If you press and hold the button for more than 2 seconds, simply releasing it cancels the picture search, and normal playback resumes.

- You can also use the **SHUTTLE** ring on the Remote. However, in this case, the TimeScan function is not activated. When using **SHUTTLE** ring, see page 37.

To resume normal playback, press **PLAY** (▶).

NOTES:

- The search speed is 7 times normal playback speed for SP recordings, and 21 times normal for EP recordings.
- TimeScan will be automatically engaged during high-speed search on a tape recorded in the SP mode.
- If the recorded tape speed changes from SP to EP during high-speed search, the TimeScan mode will change to EP search mode.
- During high-speed search on a tape recorded in the EP mode, pressing **FF** (▶▶) or **REW** (◀◀) for the opposite direction or turning the **TIME SCAN SHUTTLE** ring on the front panel to the opposite direction changes it to 7x-speed TimeScan search. (☞ pg. 37)

■ Variable-Speed Picture Search:

You can change the speed of picture search.

How to use the TIME SCAN SHUTTLE ring on the front panel:

Turn the **TIME SCAN SHUTTLE** ring to the right (forward search) or to the left (reverse search).

When you release the ring, it remains at the position where you turn it, and picture search continues. Each time it passes a click position, the playback speed changes (see the diagram on the next page.)

How to use the buttons on the Remote:

To do forward picture search, press ►► repeatedly.

Each time you press the button, the search speed increases.

- To decrease the speed during forward picture search (toward normal playback, then reverse picture search), press ◀◀ repeatedly.

To do reverse picture search, press ◀◀ repeatedly.

Each time you press the button, the search speed increases during reverse picture search.

- To decrease the speed during reverse picture search (toward normal playback, then forward picture search), press ►► repeatedly.

To resume normal playback, press **PLAY** (►).

B Viewing still picture

— Still Picture Playback

Press **PAUSE** (⏸) during normal playback.

Playback is frozen and a still picture appears.

- When “TIMESCAN AUDIO” is set to “ON” (default setting), the sounds of the last 3 seconds are reproduced repeatedly until you resume the normal playback or advance (or reverse) the still pictures.

To resume normal playback, press **PLAY** (►).

NOTE:

To obtain a noiseless still picture, it may be necessary to adjust tracking in slow motion playback before starting still picture playback.

C Viewing still picture frame by frame — Frame-by-Frame Playback

1 Pause during playback

Press **PAUSE** (⏸).

Playback is frozen and a still picture appears.

- When “TIMESCAN AUDIO” is set to “ON” (default setting), the sounds of the last 3 seconds are reproduced repeatedly until you resume the normal playback or advance (or reverse) the still pictures.

2 Advance or reverse still picture

On the front panel:

To advance a still picture, press **PAUSE** (⏸) repeatedly.

On the Remote:

To advance a still picture, press ►► (or **PAUSE** (⏸)) repeatedly.

To reverse a still picture, press ◀◀ repeatedly.

- You can also use the **JOG** dial on the Remote. However, in this case, the TimeScan function is not activated.

- ① Press **JOG/SHUTTLE** so that the **JOG/SHUTTLE** lamp lights.
- ② Turn the **JOG** dial to the right or to the left.

To resume normal playback, press **PLAY** (►).

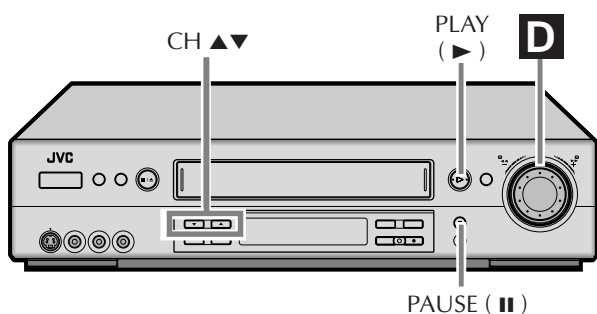

D Viewing slow motion picture

— Slow Motion Playback (Pro-Slow*)

On the front panel:

During normal playback or still picture playback:

Turn the **TIME SCAN SHUTTLE** ring slowly to the right (forward slow motion) or to the left (reverse slow motion) so that slow motion playback starts. When you release the ring, it remains at the position where you turn it, and slow motion playback (or picture search) continues. Each time it passes a click position, the playback speed changes (see the diagram on page 37.)

- Holding **PAUSE (||)** for more than 2 seconds also starts forward slow motion playback. If you press **PAUSE (||)** again, still picture resumes.

On the Remote:

During normal playback:

Press **I◀◀** to decrease the playback speed.

Each time you press the button, the speed decreases (toward reverse slow motion playback, then reverse picture search).

- Holding **PAUSE (||)** for more than 2 seconds also starts forward slow motion playback. If you press **PAUSE (||)** again, still picture resumes.

To resume normal playback, press **PLAY (▶)**.

During still picture playback:

Press and hold **▶▶** to start forward (or **I◀◀** to start reverse) slow motion playback. When you release the button, slow motion playback stops and a still picture appears.

- Holding **PAUSE (||)** for more than 2 seconds also starts forward slow motion playback. If you press **PAUSE (||)** again, still picture resumes.

To resume normal playback, press **PLAY (▶)**.

NOTES:

* *Pro-Slow enables smooth slow motion playback delivering an uninterrupted moving picture without distortion. Pro-Slow cannot be activated by pressing **PAUSE (||)** for more than 2 seconds.*

- *Manual tracking is possible during slow motion playback. During slow motion playback, simply press **CH ▲** and **▼** on the front panel or **CH +** or **-** on the Remote to adjust tracking.*

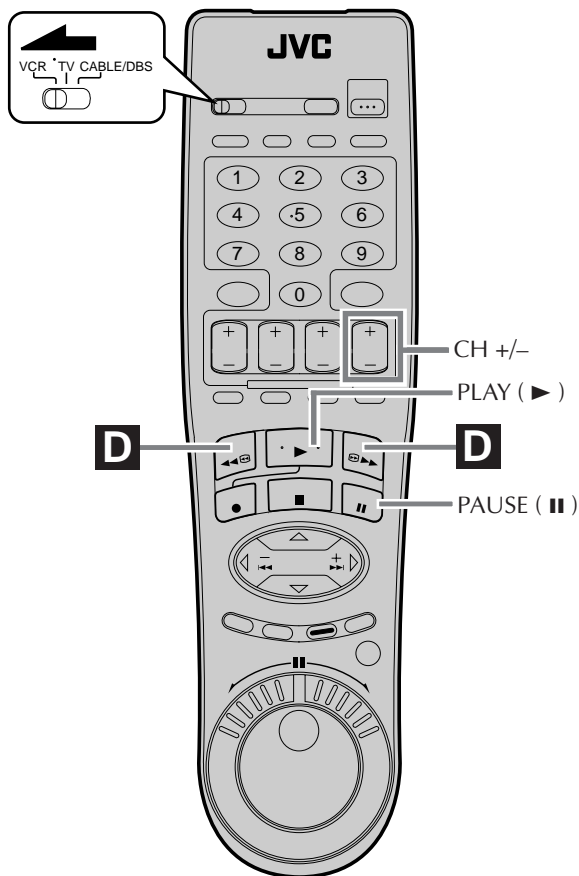

TimeScan function

Names of special-effects playback	Reverse						Forward								
	Search		Play	Slow-Motion (Pro-Slow)		Still	Slow-Motion (Pro-Slow)		Play	Search					
Speed	-7x	-5x	-3x	-1x	-1/2x	-1/3x	0	1/3x	1/2x	1x	1.5x	2x	3x	5x	7x
Audio output	Audio is output.			Audio is not output.		Audio is output.	Audio is output.	Audio is output.							

- When "SUPERIMPOSE" is set to "ON", the search speed will be shown on the TV screen for approx. 5 seconds.
- The TimeScan search speed is the same for SP and EP recordings.
- Picture may be distorted at the position where the recording speed is switched or when you change the search speed.
- During high-speed picture search on a tape containing both SP and EP recordings, the search speed will change automatically to 7x normal playback speed when the recording tape speed switches from EP to SP.
- Depending on the tape in use, noise may appear or the upper part of the picture may be distorted.
- Picture may appear distorted in comparison to normal playback.
- In TimeScan mode there will be a time lag between the video and the audio, and noise may appear in the audio signal.
- TimeScan sound quality will differ in comparison to normal playback.
- When material such as music videos where there is non-stop sound (very few breaks in the soundtrack) are viewed at 2x normal speed, the audio playback may be faster than normal.
- When the playback direction is reversed, it takes approximately 6 seconds until sound is heard.
- $\pm 1/3x$ slow motion playback is possible with SP recordings only.
- Sound may not be clear during forward slow motion playback.
- Noise may not be reduced completely during Pro Slow. When this happens, try manual tracking (☞ pg. 25).

Sounds reproduced by the TimeScan function

The sounds reproduced by the TimeScan function do not synchronize with pictures played back on the TV screen, becomes monaural, and differ from the ones you hear during normal playback.

During picture search, the TimeScan function skips sounds intermittently to keep up with the pictures played back (except 1.5x picture search).

- During 1.5x picture search, all audio signals are reproduced (the audio playback speed will be 1.5 times normal speed).

If you do not want to hear sounds during picture search with the TimeScan function, set "TIMESCAN AUDIO" to "OFF". (☞ pg. 60).

Playback tape

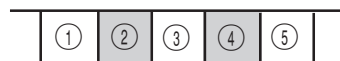

Sound of ①, ③ and ⑤ is heard.
Sound of ② and ④ is not heard.

How to use the SHUTTLE ring on the Remote

- ① Press **JOG/SHUTTLE** so that the JOG/SHUTTLE lamp lights.
- ② Turn the **SHUTTLE** ring fully to the right or to the left. When you release the ring, a still picture appears.
 - If you turn the ring fully and release it within 1 second, picture search continues.

NOTE:

The operations by the SHUTTLE ring on the Remote do not activate the TimeScan function; noise will appear on the screen and audio will not be output.

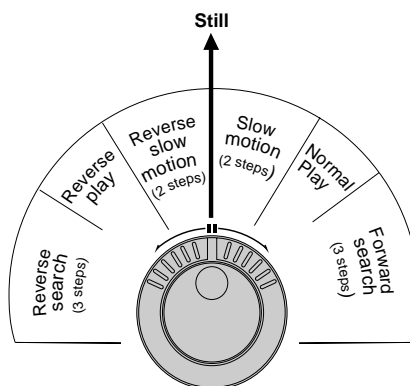

VCR Plus+® Timer Programing

Turn on the VCR and the TV, and select the VCR channel 3 or 4 (or AV mode) on the TV.

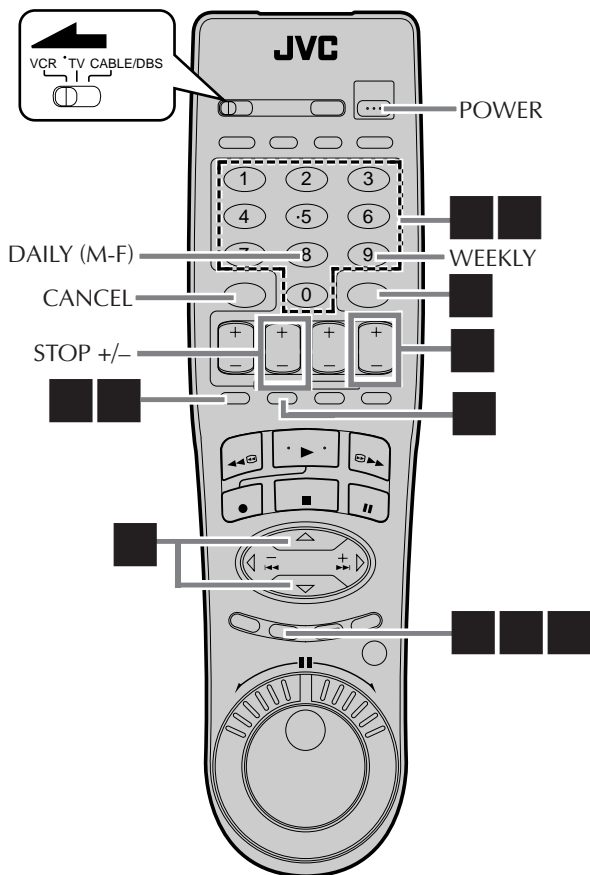
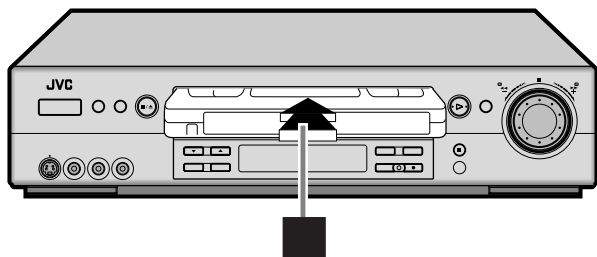

Timer recording allows you to program the VCR to automatically record a broadcast at some future time. Up to 8 timer recording programs can be made using VCR Plus+ timer programming or Express timer programming method (see pg. 42) as far as a year in advance.

The VCR Plus+ timer programming system eliminates the need to input channel, date, start and stop time data when programming timer recording settings. Simply key in the PlusCode number for the TV broadcast you wish to record and the VCR's timer will be automatically programmed. (The PlusCode programming numbers are the numbers next to the program in most TV listing.)

Load a cassette

Make sure the record safety tab is intact. If not, cover the hole with adhesive tape, then load it into the VCR.

- The VCR turns on, and the counter is reset, automatically.

Access VCR Plus+ screen

Press **PROG.** on the Remote.

- The clock must be set to access the VCR Plus+ screen.

If you have not set the clock, the Main Menu screen appears after an error message is displayed. Refer to page 8 for the Plug & Play setting or page 10 for the clock setting procedure.

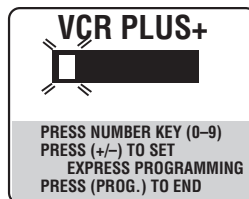

Enter PlusCode number

Press the appropriate **Number** keys to input the PlusCode number printed in the TV listings for the TV broadcast you wish to record, then press **OK**.

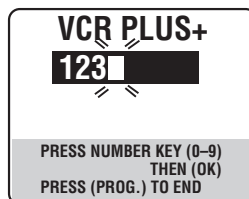

Then;

If the Guide Channel Set screen appears
— go to step ■.

If the VCR Plus+ Program screen appears
— go to step ■.

- To make corrections, press **CANCEL** and input the correct PlusCode number.

Input receiving channel number

The guide channel number, which is assigned to the TV or cable station for the PlusCode number that you entered in step ■, will appear automatically on the Guide Channel Set screen.

Press the **Number** keys (or **CH +/-** or $\Delta \nabla$) to input the number of the channel on which the broadcast for the PlusCode number is received on the VCR or cable box, then press **OK**.

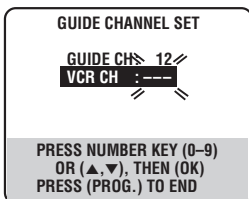

- The Guide Channel Set screen appears only when you input the PlusCode number of a station for which the guide channel number has not been set previously.
- If you receive your channels with a cable box and if you have properly set your Controller, "CABLE CH" appears in place of "VCR CH". If not, refer to pages 16 – 19.

Check program date

The PlusCode number you entered and the corresponding timer recording program is displayed on the Program screen. Check to make sure it is accurate.

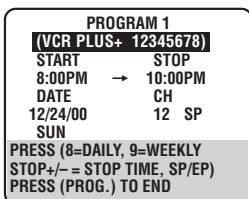

- To change the stop time, press **STOP +/-**.
- To timer-record daily (Monday–Friday) or weekly serials, press **DAILY (M-F)** (number "8") or **WEEKLY** (number "9"). "DAILY" or "WEEKLY" appears on the Program screen. Pressing the button again makes each corresponding display disappear.
- If you made a mistake, press **CANCEL** to access the VCR Plus+ screen again and input the correct PlusCode number.
- If an incorrect PlusCode number or the one for a broadcast already finished has been inputted, "ERROR" is displayed for about 5 seconds, then the VCR Plus+ screen reappears.

Set tape speed

Press **SP/EP (///)**.

IMPORTANT

If you have moved to a different area or if a broadcasting station's channel number has been changed, the wrong VCR CH or CABLE CH number will be displayed on the Program screen in step ■. When this happens, set the correct guide channel number for that station. (☞ pg. 40, "Changing VCR Plus+ Setting")

Return to normal screen

Press **PROG.** or **OK**.

"PROGRAM COMPLETED" appears on the screen for about 5 seconds, then normal screen appears.

- If "PROGRAM NOT COMPLETED PROGRAM OVERLAP" appears, you have another program overlapping the program you have just made. The Program Check screen appears and conflicting programs will start blinking. You can now correct the conflicting programs. See "When programs overlap each other" on page 45.

Engage timer recording standby mode

Press **TIMER**.

The VCR turns off automatically and "⊕" is displayed on the front display panel.

To use the VCR while it is in timer recording standby mode

Press **TIMER** to cancel the timer recording standby mode, then press **POWER** to turn on the VCR.

DO NOT forget to put the VCR into timer recording standby mode again by pressing **TIMER** after you use the VCR; otherwise, you cannot record the broadcasts you want.

- When "AUTO TIMER" (☞ pg. 57) is set to "ON", the timer recording standby mode is automatically engaged when the VCR is turned off. It is temporarily canceled when the VCR is turned on. You do not have to press **TIMER** to engage or disengage the timer recording standby mode.

NOTES:

- Even if a power failure occurs, the VCR keeps your timer programs. However, the clock time, channel settings, and other menu settings are lost if it lasts for more than 3 minutes. As a result, when the power is supplied again to this VCR after the power failure, the following will take place.
 1. This VCR starts the Plug & Play setting automatically to restore the clock time and channel setting.
 2. If the clock time and channel setting are restored correctly, each timer program you have made will start at its start time unless its end time has elapsed.
- To timer-record cable channels received through a cable box, be sure to keep the cable box turned on.
- If "MEMORY FULL" appears on the display when you finish a program setting, the VCR's memory for the Video Navigation function is full (☞ pg. 46). This is not related to actual recording, so you can finish recording normally, but the Video Navigation information such as recording date, start time, end time, and channel number will not be stored in memory.

Changing VCR Plus+ Setting

Turn on the VCR and the TV, and select the VCR channel 3 or 4 (or AV mode) on the TV.

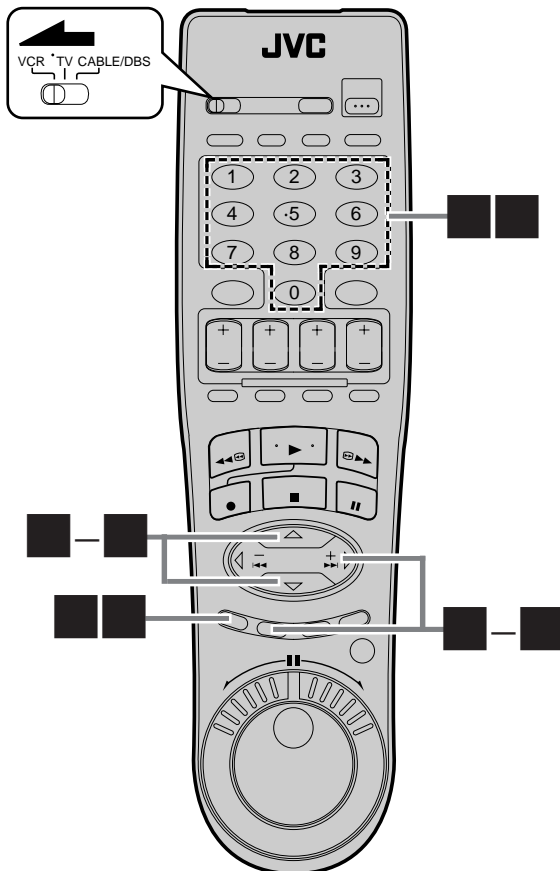
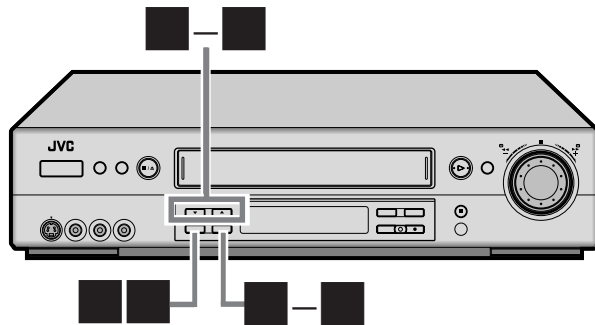

IMPORTANT

If you have moved to a different area or if a broadcasting station's channel number has been changed, the wrong VCR CH or CABLE CH number will be displayed on the Program screen (➤ step ■ on page 39). When this happens, perform the following steps to set the correct guide channel number for that station.

To ensure that VCR Plus+ timer recording operates correctly, it is necessary to set the VCR Plus+ "Guide Channel Set" for each station. Read the following information carefully.

VCR Plus+ guide channel matching

The VCR Plus+ programming system assigns a VCR Plus+ guide channel to the TV channels and the cable channels. These guide channel numbers are also called the VCR Plus+ channel codes. Most TV listings have a section, usually a chart, indicating the guide channel numbers assigned to each station. For accurate VCR Plus+ programming, the VCR Plus+ guide channel number for each station should match the channel number on which it is received in your area.

NOTES:

- In many instances, the VCR Plus+ guide channel numbers for cable and broadcast TV stations DO NOT match the channel number on which it is received by your VCR or cable box. Check your TV listing, or contact your cable supplier for details.
- Many TV stations can be viewed on cable. Check your TV listing, or contact your cable supplier for details.

Access Main Menu screen

Press **MENU**.

Access Initial Set screen

On the front panel:

Press **CH▲▼** to move the highlight bar (arrow) to "INITIAL SET", then press **OK**.

On the Remote:

Press **△▽** to move the highlight bar (arrow) to "INITIAL SET", then press **OK** or **▷**.

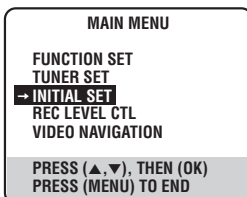

Access Guide Channel Set screen

On the front panel:

Press **CH▲▼** to move the highlight bar (arrow) to "GUIDE CHANNEL SET", then press **OK**.

On the Remote:

Press **△▽** to move the highlight bar (arrow) to "GUIDE CHANNEL SET", then press **OK** or **▷**.

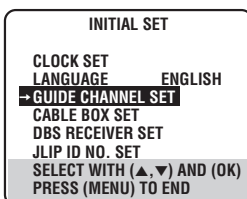

Input guide channel number

On the front panel:

Press **CH▲▼** to select the VCR Plus+ guide channel number as shown in the TV listing, then press **OK**.

On the Remote:

Press the **Number** keys or **△▽** to input the VCR Plus+ guide channel number as shown in the TV listing, then press **OK** or **▷**.

(Ex.) When inputting the guide channel number 6 for WNJU(Ind.)

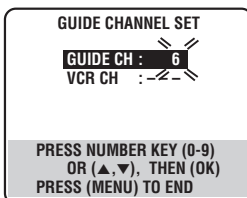

- If you receive your channels with a cable box and if you have properly set your Controller, "CABLE CH" appears in place of "VCR CH". If not, refer to pages 16 – 19 and re-perform the procedure.

Input receiving channel number

On the front panel:

Press **CH▲▼** to select the number of the channel on which the guide channel's broadcasts are received, then press **OK**.

On the Remote:

Press the **Number** keys or **△▽** to input the number of the channel on which the guide channel's broadcasts are received, then press **OK** or **▷**.

(Ex.) If WNJU(Ind.) is received on channel 47

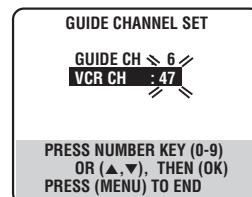

- Repeat steps ■ and ■ for each instance.

Return to normal screen

Press **MENU**.

Express Timer Programming

Turn on the VCR and the TV, and select the VCR channel 3 or 4 (or AV mode) on the TV.

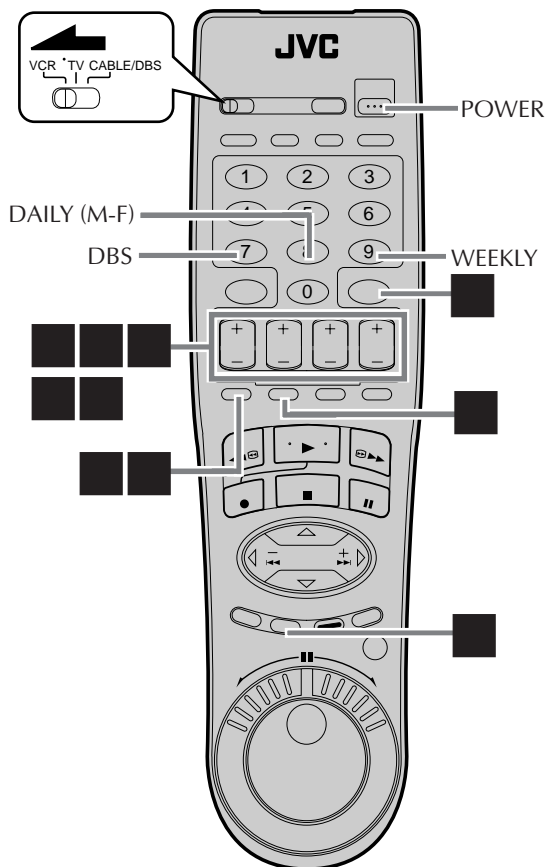
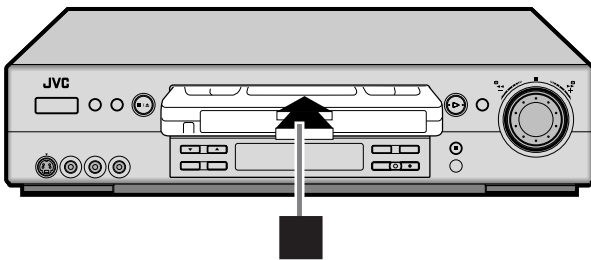

You can directly program the VCR's timer to record up to 8 broadcasts, as far as a year in advance. Remember, the clock must be set before you can program the timer (pg. 8 or 10).

Load a cassette

Make sure the record safety tab is intact. If not, cover the hole with adhesive tape, then load it into the VCR.

- The VCR turns on, and the counter is reset, automatically.

Access VCR PLUS+ screen

Press **PROG.**.

Access Program screen

Press **START +/-** once.
(If no program is stored, "PROGRAM 1" appears.)

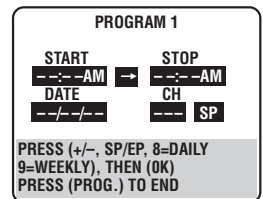

Set program start time

Press **START +/-** repeatedly to enter the time you want recording to start.

- Press and hold **START +/-** to increase the time in 30-minute intervals.

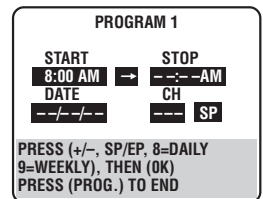

Set program stop time

Press **STOP +/-** repeatedly to enter the time you want recording to stop.

- Press and hold **STOP +/-** to increase the time in 30-minute intervals.

Set program date

Press **DATE +/-**. (The current date is displayed on the screen. The date you enter appears in its place.)

Set channel number

Press **CH +/-**.

- If you are using a DBS receiver, see "ATTENTION FOR DBS RECEIVER USERS" on next page.
- Holding down **CH +/-** rapidly changes the channel numbers.

Set tape speed

Press **SP/EP** (*///*) to set the tape speed.

Return to normal screen

Press **PROG.** or **OK**.

“PROGRAM COMPLETED” appears on the screen for about 5 seconds, then normal screen appears.

- If “PROGRAM NOT COMPLETED PROGRAM OVERLAP” appears, you have another program overlapping the program you have just made. The Program Check screen appears and conflicting programs will start blinking. You can now correct the conflicting programs. See “When programs overlap each other” on page 45.

Engage timer recording standby mode

Press **TIMER**.

The VCR turns off automatically and “⊕” is displayed on the front display panel.

To timer-record daily (Monday–Friday) or weekly serials

Press **DAILY (M-F)** (number “8”) or **WEEKLY** (number “9”) anytime during steps ■ through ■.

“DAILY” or “WEEKLY” appears on the Program screen.

- Pressing the button again makes the corresponding indication disappear.

To use the VCR while it is in timer recording standby mode

Press **TIMER** to cancel the timer recording standby mode, then press **POWER** to turn on the VCR. DO NOT forget to put the VCR into timer recording standby mode again by pressing **TIMER** after you use the VCR; otherwise, you cannot record the broadcast you want.

- When “AUTO TIMER” (*☞* pg. 57) is set to “ON”, the timer recording standby mode is automatically engaged when the VCR is turned off. It is temporarily canceled when the VCR is turned on. You do not have to press **TIMER** to engage or disengage the timer recording standby mode.

NOTES:

- Even if a power failure occurs, the VCR keeps your timer programs. However, the clock time, channel settings, and other menu settings are lost if it lasts for more than 3 minutes. As a result, when the power is supplied again to this VCR after the power failure, the following will take place.
 1. This VCR starts the Plug & Play setting automatically to restore the clock time and channel setting.
 2. If the clock time and channel setting are restored correctly, each timer program you have made will start at its start time unless its end time has elapsed.
- Programs that start after midnight must have the next day's date.
- After timer recording is completed, the VCR turns off automatically.
- You can program the timer recording while a regular recording is in progress; the menu screens will not be recorded.
- If the tape reaches its end during timer recording, the cassette is automatically ejected.
- To timer-record cable or satellite channels, be sure to keep the cable box or DBS receiver turned on.
- If “MEMORY FULL” appears on the display when you finish a program setting, the VCR's memory for the Video Navigation function is full (*☞* pg. 46). This is not related to actual recording, so you can finish recording normally, but the Video Navigation information such as recording date, start time, end time, and channel number will not be stored in memory.

ATTENTION FOR DBS RECEIVER USERS

If you are using a DBS receiver (unless “DBS RECEIVER SET” is set to “OFF” *☞* pg. 21), the band indication (TV, CATV or DBS) appears under the channel number indication.

PROGRAM 1			
START	→	STOP	
8:00AM		9:00PM	
DATE		CH	
12/24/00		110	SP
SUN		DBS	
PRESS (+/-, SP/EP, 8=DAILY 9=WEEKLY, 7=DBS), THEN (OK) PRESS (PROG.) TO END			

TV :To timer-record a regular TV broadcast received on the VCR.

CATV :To timer-record a cable TV broadcast received on the VCR, or through a cable box (unless “CABLE BOX SET” is set to “OFF” *☞* pg. 18).

DBS :To timer-record a satellite broadcast received through a DBS receiver.

NOTE:

If “BAND” is set to “TV” on the Tuner Set screen (*☞* pg. 13) and “CABLE BOX SET” is set to “OFF” on the Cable Box Set screen (*☞* pg. 18), “CATV” will not be displayed on the Program screen; If “BAND” is set to “CATV” or “CABLE BOX SET” is set to “ON”, “TV” will not be displayed.

If the channel number entered requires that the band be set, “7=DBS” is displayed on the screen.

If this happens, press the **Number** key “7 (DBS)” to select “DBS”.

Turn on the VCR and the TV, and select the VCR channel 3 or 4 (or AV mode) on the TV.

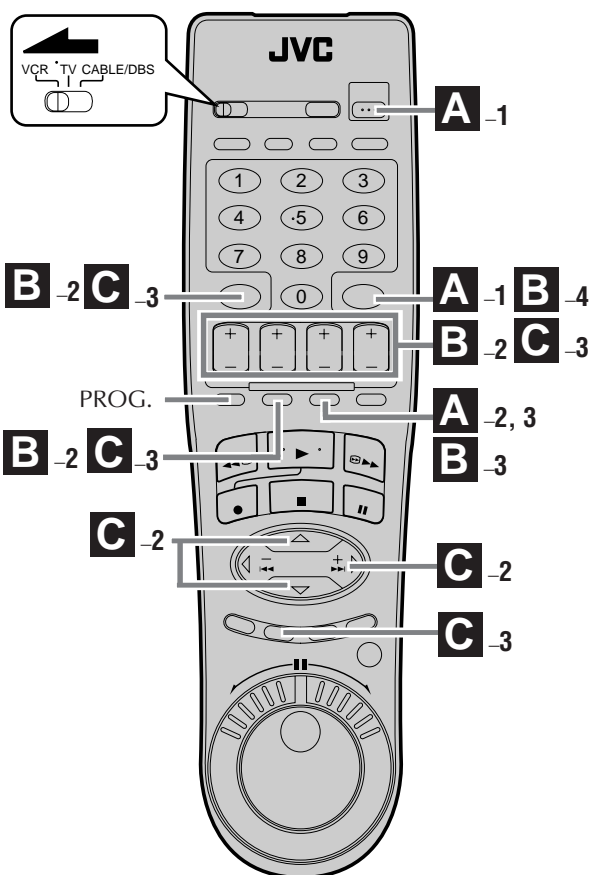

Other Useful functions for timer recording

You can also use the following functions for timer recording.

• Auto Timer (pg. 57)

When "AUTO TIMER" is set to "ON", the timer recording standby mode is automatically engaged when the VCR is turned off. It is temporarily canceled when the VCR is turned on. You do not have to press **TIMER** to engage or disengage the timer recording standby mode.

• Auto SP → EP Timer (pg. 58)

If there is not enough tape to record the entire broadcast for recording in SP mode, the VCR automatically switches to EP mode to allow complete recording. This feature is especially handy when recording a broadcast of more than 2 hours in length.

A Checking program settings

1 Disengage timer

Press **TIMER**, then press **POWER**.

- When "AUTO TIMER" (pg. 57) is set to "ON", you do not have to press **TIMER**.

2 Access Program Check screen

Press **PROG. CHECK**.

PR	START	STOP	CH	DATE
1	8:00P	10:00	12	12/24
2	10:00A	10:45	40	12/25
3	11:30P	1:00	125	12/25
4				
5				
6				
7				
8				

PRESS (CHECK) TO NEXT

3 Access Program screen

Press **PROG. CHECK** again to check more detailed information. Each time you press **PROG. CHECK**, the next program's Program screen appears. When all Program screens are shown, normal screen resumes.

B Canceling or changing program settings

1 Access Program screen

Repeat steps 1 to 3 above.

2 Cancel or change program setting

To **cancel a program**, press **CANCEL** when the Program screen you do not want is shown.

To **change a program**, press the appropriate button: **START+/-**, **STOP+/-**, **DATE+/-**, **CH+/-**, and/or **SP/EP (///)** when the Program screen on which you want to make changes is shown.

3 Return to normal screen

Press **PROG. CHECK** as many times as necessary until no Program screen is shown.

4 Reengage timer recording standby mode

Press **TIMER**.

- When "AUTO TIMER" (pg. 57) is set to "ON", the timer recording standby mode automatically resumes when you turn off the VCR.

C When programs overlap each other

If "PROGRAM NOT COMPLETED PROGRAM OVERLAP" appears, you have another program overlapping the program you have just made. The Program Check screen appears and conflicting programs will start blinking.

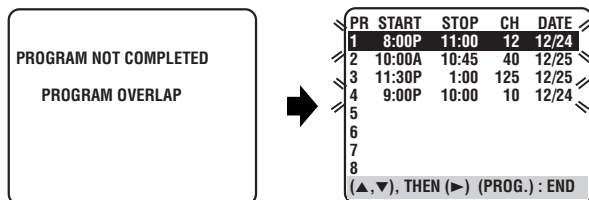

EX. Program 1 (you have just made) and Program 4 overlap each other

1 Confirm overlapping programs

Overlapping programs blink on the screen.

2 Select program to modify

Press Δ ▼, then press \triangleright .

- You can only select one of the overlapping programs.

NOTE:

If you do not mind this overlap, press **PROG.** to finish the timer program setting. See "ATTENTION" to the right. Without doing anything for about 1 minute, the VCR will finish the timer programming.

3 Cancel or change program setting

To cancel a program, press **CANCEL** when the Program screen you do not want is shown.

"PROGRAM COMPLETED" appears on the screen for about 5 seconds, then normal screen appears.

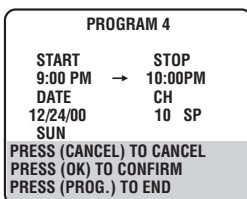

To change a program, press the appropriate button: **START+/-**, **STOP+/-**, **DATE+/-**, **CH+/-**, and/or **SP/EP (//)** when the Program screen on which you want to make changes is shown, then press **OK**.

"PROGRAM COMPLETED" appears on the screen for about 5 seconds, then normal screen appears.

NOTE:

If the overlap is not yet solved or another overlap occurs with the timer program setting made last, after making correction on a program, the conflicting programs will be shown on the Program Check screen again. Repeat the above steps again until the overlap is solved.

ATTENTION

If there is a conflict in the timer schedule and one program overlaps with another, only the parts shown below in gray will be recorded.

Pattern 1: The program with the lower program number will be recorded.

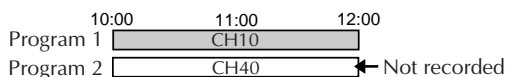

Pattern 2: The program starting earlier will be recorded.

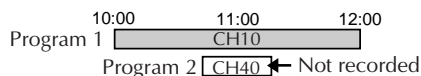

Pattern 3: The program starting earlier will be recorded, followed by the remaining portion of the other program.

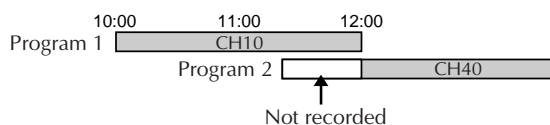

Navigation Playback

Turn on the VCR and the TV, and select the VCR channel 3 or 4 (or AV mode) on the TV.

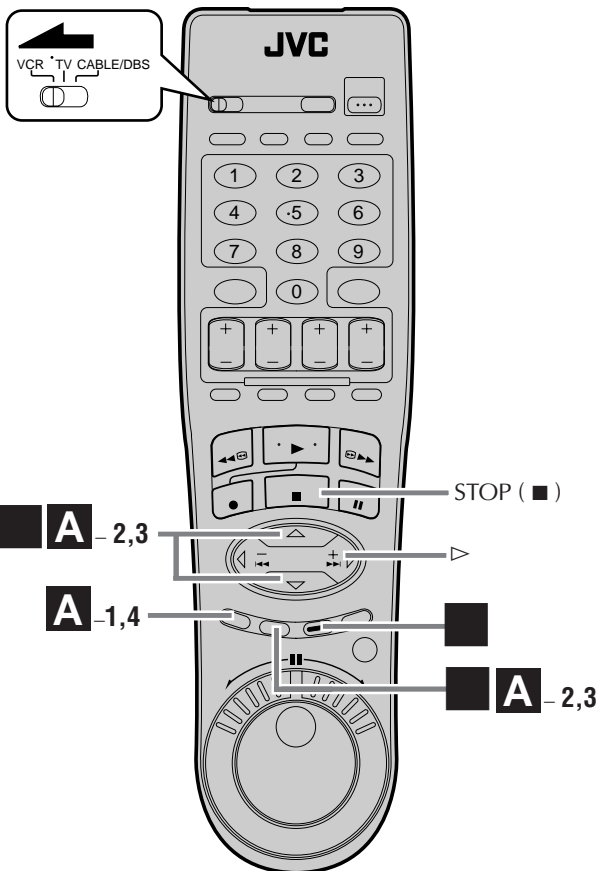
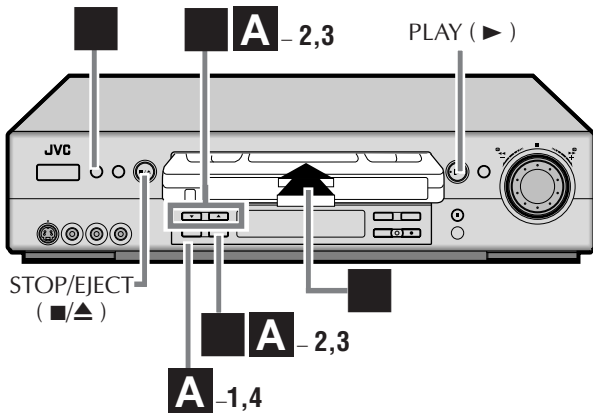

This function is useful when you want to quickly find out what programs you have recorded on a tape using this VCR. This function allows you to select a program to watch, and then automatically searches for the beginning of the program.

Load a cassette

Insert a tape recorded on this VCR.

- The VCR turns on automatically.
- The counter is automatically reset to "0:00:00".
- The tape will run for a few seconds while the VCR searches for the tape number recorded. If tape number is found, it will be shown on the TV screen if "SUPERIMPOSE" is set to "ON". (☞ pg. 56, 57)
- If the cassette's record safety tab has been removed, playback begins automatically.

Access Title screen

Press **NAVIGATION**.

- After pressing **NAVIGATION**, it may take a few seconds to access the Title screen while the VCR searches for the Video Navigation information.
- If you press **NAVIGATION** with no tape inserted, the Find Title screen appears. (☞ pg. 52)

00013	FOOTBALL 98	1/3
	BLANK	1:25 (EP)
10 : 00PM	2/26/99	CH123
11 : 00PM	2/26/99	CH 16
→ 9 : 00PM	2/26/99	CH 56
8 : 15AM	1/15/00	CH 99
9 : 00P → 10 : 30P	1 : 30 (SP)	
WORLD CUP 98 /SPORTS		
PRESS (▲, ▼), THEN (OK)		
PRESS (NAVIGATION) TO END		

Select program

On the front panel:

Press **CH ▲▼** to move the highlight bar (arrow) to the program you want to watch.

On the Remote:

Press **▲▼** to move the highlight bar (arrow) to the program you want to watch.

Start playback

Press **OK**.

Playback starts automatically after the selected program is located.

- If you want to locate the beginning of the program, but do not want to start playback, press **STOP (■)** on the Remote or **STOP/EJECT (■ / ▲)** on the front panel.

How to read the Video Navigation screen

Recording start time, date and channel no. of recorded program

1st page of the recorded programs on this tape (only 4 programs can be shown at a time)
In this case, there are two more pages.

Tape no. and tape title

If there are no tape title, the earliest recording date will be shown.

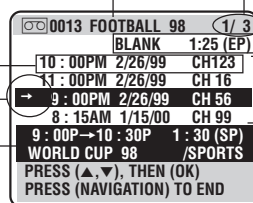

The detailed program information currently selected (start time, end time, recording length, recording speed, program title, and category)

If there are no title and category entered, "TITLE" and "CATEGORY" will be shown.

Remaining time on this tape, calculated based on the current recording speed (SP/EP) selected on this VCR.

Recorded programs on this tape

The currently selected program whose detailed information is shown below on the screen.
*If the currently selected program and the current tape position are different while tape is not running, the current tape position on the tape will be shown by "**".*

A Deactivating Video Navigation

If you do not want to store program information, you can deactivate the Video Navigation function.

1 Access Main Menu screen

Press **MENU**.

2 Access Video Navigation screen

On the front panel:

Press **CH ▲▼** to move the highlight bar (arrow) to "VIDEO NAVIGATION", then press **OK**.

On the Remote:

Press **△▽** to move the highlight bar (arrow) to "VIDEO NAVIGATION", then press **OK** or **▷**.

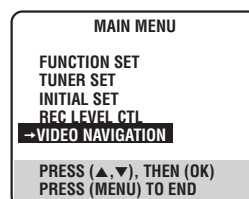

3 Deactivate Video Navigation

On the front panel:

Press **CH ▲▼** to move the highlight bar (arrow) to "NAVIGATION", then press **OK**.

On the Remote:

Press **△▽** to move the highlight bar (arrow) to "NAVIGATION", then press **OK** or **▷**.

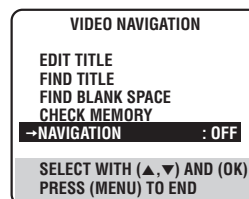

- Each time you press **OK** or **▷**, Video Navigation turns "ON" or "OFF".

4 Return to normal screen

Press **MENU**.

NOTES:

- If you press **NAVIGATION** while Video Navigation is deactivated, "NAVIGATION: OFF" appears (with "SUPERIMPOSE" set to "ON": [pg. 56, 57](#)).
- Video Navigation playback is possible only with the tape recorded on this VCR.
- To record the date and time as the program title in this VCR's memory, make sure the VCR's clock is set correctly before recording.
- To record the program information in this VCR's memory, you must record each program for over the minimum recording time; 5 min for the SP mode and 15 min for EP mode.
- Video Navigation may not work properly for some tapes.
- If the VCR finds two tape numbers in one tape while playing back or searching for the beginning of a program, the tape will be assigned just one number (smaller number) when you remove the tape.
- The program information is stored in this VCR's memory. Should the memory in this VCR be damaged and the program information be lost, it is impossible to restore that information.
- After recording a tape on this VCR, write the tape number on a label and affix the label to the tape in order to allow you to find the tape by its number.

Editing Titles

Turn on the VCR and the TV, and select the VCR channel 3 or 4 (or AV mode) on the TV.

When you record a TV program on this VCR, the VCR automatically records the recording start time, date, and channel in each program title. If the tape is recorded for the first time, the tape number and the date and time are recorded in the tape title. You can then edit the tape title and the program titles as you like. You can also edit the category in the program title.

In short, you can use the Video Navigation function to create your own video tape library.

A Editing tape title

When you want to edit the tape title, follow the procedure below by using the Remote.

1 Access Main Menu screen

Press **MENU**.

2 Access Video Navigation screen

Press Δ / ∇ to move the highlight bar (arrow) to "VIDEO NAVIGATION", then press **OK** or \triangleright .

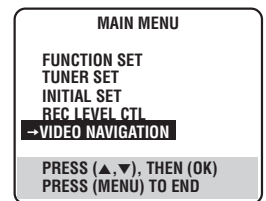

3 Access Edit Title screen

Press Δ / ∇ to move the highlight bar (arrow) to "EDIT TITLE", then press **OK** or \triangleright .



4 Select tape number

Press Δ / ∇ to move the highlight bar (arrow) to the tape number for which you want to edit the title, then press **OK** or \triangleright .

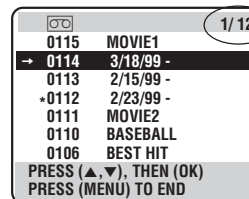

1st page (out of 12 pages in this example) of the tape number lists is shown.

- "*" indicates the tape currently inserted in the VCR.

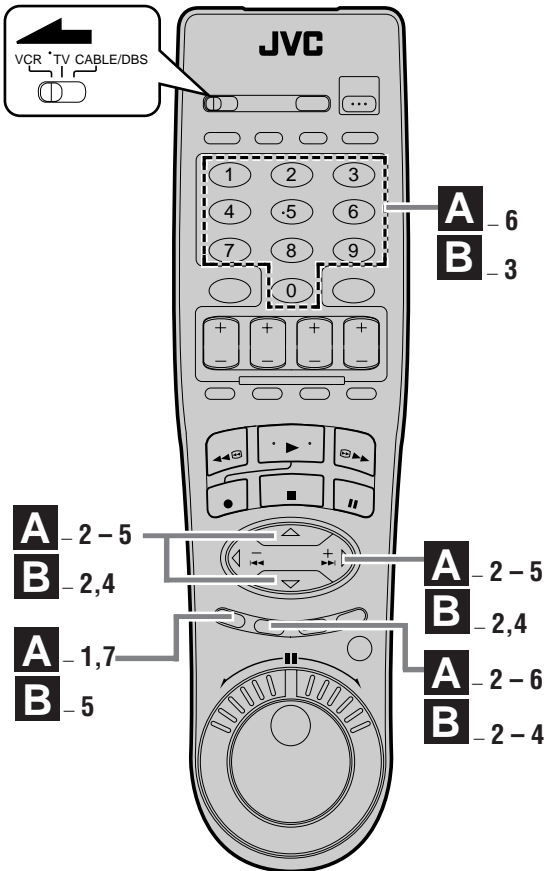

5 Select tape title

Press $\Delta\nabla$ to move the highlight bar (arrow) to the tape title column (top), then press **OK** or \triangleright .

- "*" indicates the current position on the tape.

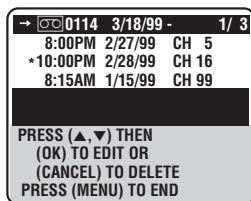

6 Enter title

Press the **Number** keys to enter the title, then press **OK**.

- For entering the characters as the title, refer to "How to enter the characters" below. (In this example, enter "JVC NEWS".)

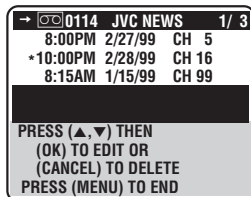

7 Return to normal screen

Press **MENU**.

How to enter the characters

Press the **Number** keys, then press \triangleright to enter each character.

Refer to the example below.

(Ex.) Enter "JVC NEWS".

- ① Press **5 (JKL)** once to enter "J", then press \triangleright .
- ② Press **8 (TUV)** three times to enter "V", then press \triangleright .
- ③ Press **2 (ABC)** three times to enter "C", then press \triangleright .
- ④ Press **0 (—)** twice to enter "—" (space), then press \triangleright .
- ⑤ Press **6 (MNO)** twice to enter "N", then press \triangleright .
- ⑥ Press **3 (DEF)** twice to enter "E", then press \triangleright .
- ⑦ Press **9 (WXYZ)** once to enter "W", then press \triangleright .
- ⑧ Press **7 (PQRS)** four times to enter "S", then press \triangleright .

NUMBER KEY	CHARACTERS
1	. , ? - + * / () 1
2	A B C 2 Ä Å Æ Ç
3	D E F 3 Ê Ë Ì
4	G H I 4 Î Ï
5	J K L 5
6	M N O 6 Ñ Ö Ø Ó Ô
7	P Q R S 7
8	T U V 8 Ù Ú Û
9	W X Y Z 9
0	0 _ (space)

NOTES:

- If you make a mistake, press $\triangleleft \triangleright$ to select the character, then enter the correct character.
- If you want to delete a character, press $\triangleleft \triangleright$ to select the character, then press **CANCEL**.

B Editing program title and category

When you want to edit the program title and its category, follow the procedure below by using the Remote.

1 Follow steps 1 to 4 on page 48, then go to the following steps.

2 Select program

Press $\Delta\nabla$ to move the highlight bar (arrow) to the program you want to edit, then press **OK** or \triangleright .

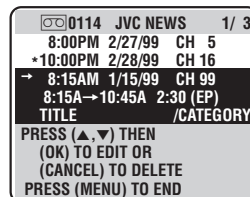

3 Enter title

Press the **Number** keys to enter the title, then press **OK**.

- For entering the characters as the title, refer to "How to enter the characters" to the left. (In this example, enter "WORLD CUP 98".)

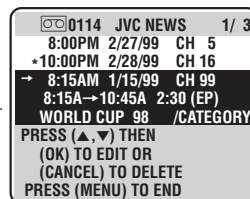

4 Select category

Press $\Delta\nabla$ to select the category you want, then press **OK** or \triangleright .

- Each time you press $\Delta\nabla$, category changes as follows: (In this example, select "SPORTS".)

↔ CATEGORY ↔ MOVIE ↔ SPORTS
↔ SPECIAL ↔ SERIES ↔ NEWS ↔ CHILDREN
↔ SHOPPING ↔ (back to the beginning)

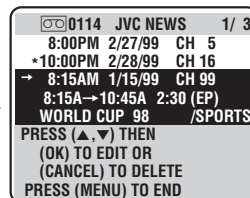

5 Return to normal screen

Press **MENU**.

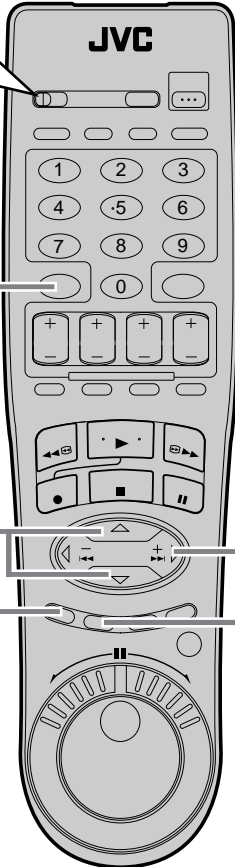
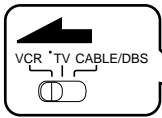
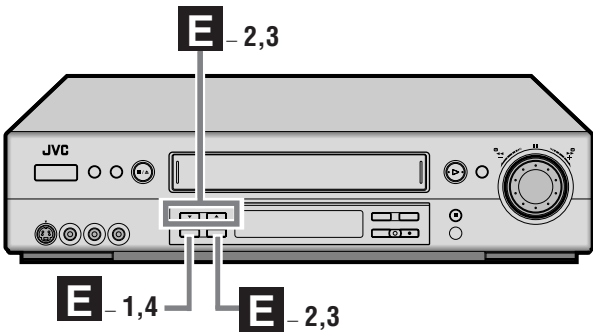

C-2 **D**-2

C-2,3 **D**-2,3
E-2,3

C-4 **D**-4

E-1,4

C-3

D-3

E-2,3

C Deleting tape information

When you want to delete the entire tape information (information for all recorded programs on the tape), follow the procedure below by using the Remote.

- Tape information for the Video Navigation function is deleted, but the recorded programs will not be erased.

1 Follow steps 1 to 4 on page 48, then go to the following steps.

2 Select tape title

Press Δ / ∇ to move the highlight bar (arrow) to the tape title column (top) you want to delete, then press **CANCEL**.

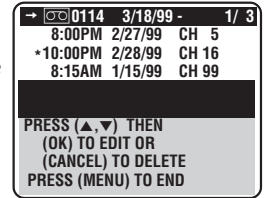

3 Delete tape information

Press Δ / ∇ to move the highlight bar (arrow) to "YES", then press **OK** or \triangleright .

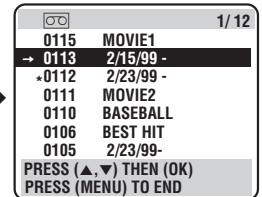
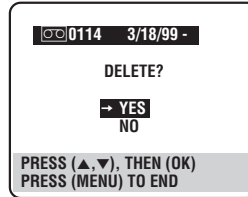

- If you stop deleting tape information, move the highlight bar (arrow) to "NO", then press **OK** or \triangleright .

4 Return to normal screen

Press **MENU**.

D Deleting program information

When you want to delete the stored information for each recorded program, follow the procedure below by using the Remote.

- Program information for the Video Navigation function is deleted, but the recorded program will not be erased.

1 Follow steps 1 to 4 on page 48, then go to the following steps.

2 Select program

Press Δ / ∇ to move the highlight bar (arrow) to the program you want to delete, then press CANCEL.

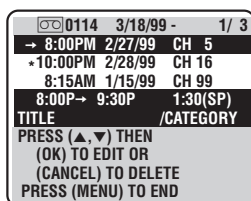

3 Delete program information

Press Δ / ∇ to move the highlight bar (arrow) to "YES", then press OK or \triangleright .

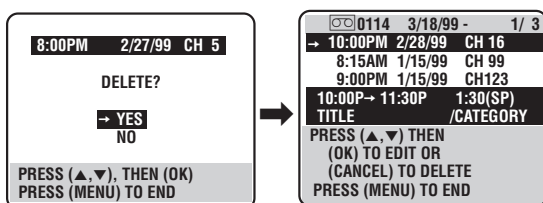

- If you stop deleting tape information, move the highlight bar (arrow) to "NO", then press OK or \triangleright .

4 Return to normal screen

Press MENU.

E Checking memory

You can check the amount of recorded information in the VCR's memory.

1 Access Main Menu screen

Press MENU.

2 Access Video Navigation screen

Press Δ / ∇ to move the highlight bar (arrow) to "VIDEO NAVIGATION", then press OK or \triangleright .

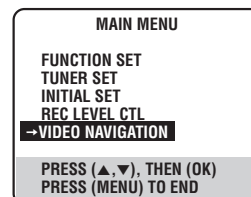

3 Check memory

On the front panel:

Press CH \blacktriangle / \blacktriangledown to move the highlight bar (arrow) to "CHECK MEMORY", then press OK.

On the Remote:

Press Δ / ∇ to move the highlight bar (arrow) to "CHECK MEMORY", then press OK or \triangleright .

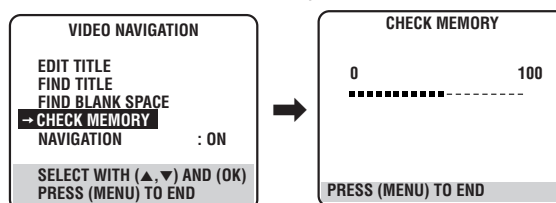

The Check Memory screen appears.

When the scale bar reaches "100" on the TV screen, memory is full and "MEMORY FULL" appears.

4 Return to normal screen

Press MENU.

If memory is full, you have to delete unwanted information to store more information in the VCR's memory.

Finding Tapes

Turn on the VCR and the TV, and select the VCR channel 3 or 4 (or AV mode) on the TV.

You can find a tape you want using Video Navigation. You have four methods to find tapes; by tape number, by recording date, by category, and by tape remaining time.

A Finding by tape number

Use the Remote to do the following operations.

1 Access Main Menu screen

Press MENU.

2 Access Video Navigation screen

Press $\Delta \nabla$ to move the highlight bar (arrow) to "VIDEO NAVIGATION", then press OK or \triangleright .

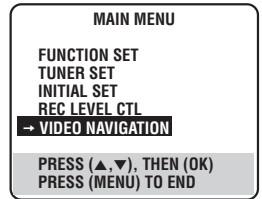

3 Access Find Title screen

Press $\Delta \nabla$ to move the highlight bar (arrow) to "FIND TITLE", then press OK or \triangleright .



4 Access tape number screen

Press $\Delta \nabla$ to move the highlight bar (arrow) to "TAPE NO.", then press OK or \triangleright .

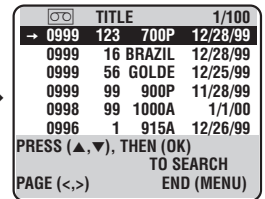
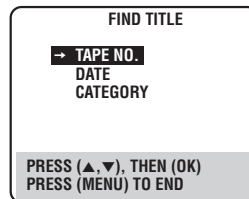

The tape number list screen appears, being sorted by the tape numbers.

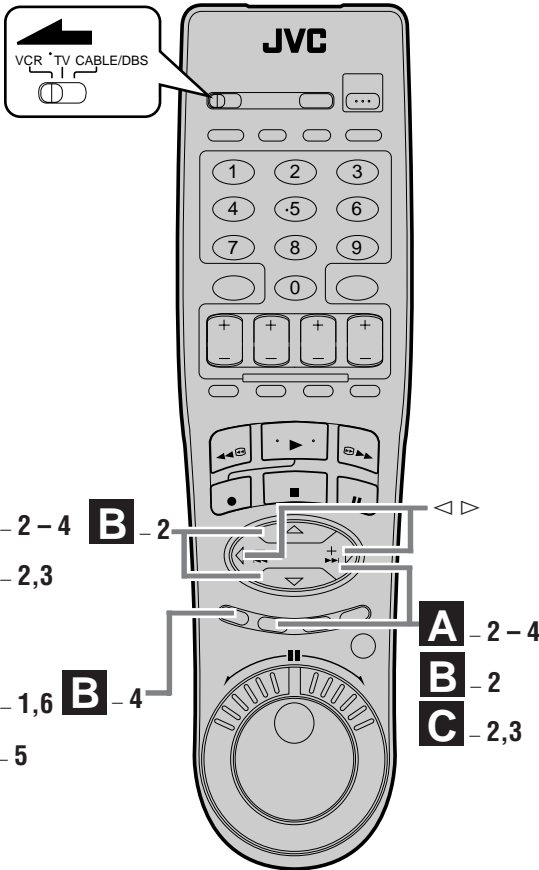

A - 2-4
B - 2
C - 2,3

A - 1,6
B - 4
C - 5

A - 2-4
B - 2
C - 2,3

NOTE:

You can display the Find Title screen on the TV screen by pressing NAVIGATION when no tape is inserted.

5 Conform tape number lists

TITLE	1/100
→ 0999 123 700P 12/28/99	
0999 16 BRAZIL 12/28/99	
0999 56 GOLDE 12/25/99	
0999 99 900P 11/28/99	
0998 99 1000A 1/1/00	
0996 1 915A 12/26/99	

PRESS (▲, ▼), THEN (OK)
TO SEARCH
PAGE (<, >) END (MENU)

1st page (out of 100 pages in this example) of the tape number lists is shown.

- To go to another page of the lists, press < >.
- If you press ▲▼ then press **OK** to select the tape number, the VCR will go into the Search Mode for the selected tape. (☞ pg. 55)

6 Return to normal screen

Press **MENU**.

B Finding by recording date

Use the Remote to do the following operations.

1 Follow steps 1 to 3 on page 52, then go to the following steps.

2 Access tape number screen

Press ▲▼ to move the highlight bar (arrow) to "DATE", then press **OK** or ▷.

FIND TITLE
TAPE NO.
→ DATE
CATEGORY

PRESS (▲, ▼), THEN (OK)
PRESS (MENU) TO END

TITLE	1/100
→ 0993 LOST WORL 1/15/00	
0998 99 1000A 12/30/99	
0999 FOOTBALL 12/26/99	
0999 F1 BRAZIL 12/26/99	
0999 007 GOLDE 11/15/99	
0994 181 115P 11/14/99	

PRESS (▲, ▼), THEN (OK)
TO SEARCH
PAGE (<, >) END (MENU)

The tape number list screen appears, being sorted by the recording date.

3 Confirm tape number lists

- To go to another page of the lists, press < >.
- If you press ▲▼ then press **OK** to select the tape number, the VCR will go into the Search Mode for the selected tape. (☞ pg. 55)

4 Return to normal screen

Press **MENU**.

C Finding by category

Use the Remote to do the following operations.

1 Follow steps 1 to 3 on page 52, then go to the following steps.

2 Access tape number screen

Press ▲▼ to move the highlight bar (arrow) to "CATEGORY", then press **OK** or ▷.

FIND TITLE
TAPE NO.
DATE
→ CATEGORY

PRESS (▲, ▼), THEN (OK)
PRESS (MENU) TO END

3 Select category

Press ▲▼ to move the highlight bar (arrow) to the category you want, then press **OK** or ▷.

→ MOVIE
SPORTS
SPECIAL
SERIES
NEWS
CHILDREN
SHOPPING

PRESS (▲, ▼), THEN (OK)
PRESS (MENU) TO END

TITLE	1/3
→ 0993 LOST WORL 1/15/00	
0998 99 1000A 12/30/99	
0999 FOOTBALL 12/26/99	
0999 F1 BRAZIL 12/26/99	
0999 007 GOLDE 11/15/99	
0994 181 115P 11/14/99	

PRESS (▲, ▼), THEN (OK)
TO SEARCH
PAGE (<, >) END (MENU)

The tape number list screen of the selected category appears.

4 Confirm tape number lists

- To go to another page of the lists, press < >.
- If you press ▲▼ then press **OK** to select the tape number, the VCR will go into the Search Mode for the selected tape. (☞ pg. 55)

5 Return to normal screen

Press **MENU**.

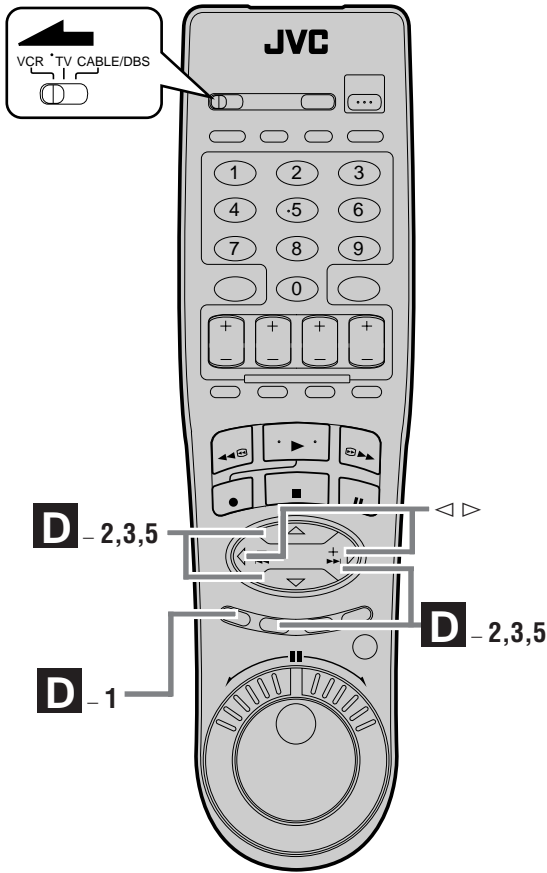

D Finding by remaining time

You can find a tape whose remaining time is enough for a program you want to record.

- The remaining time can be calculated based on the recording speed currently selected on this VCR.

Use the Remote to do the following operations.

1 Access Main Menu screen

Press **MENU**.

2 Access Video Navigation screen

Press $\Delta \nabla$ to move the highlight bar (arrow) to "VIDEO NAVIGATION", then press **OK** or \triangleright .

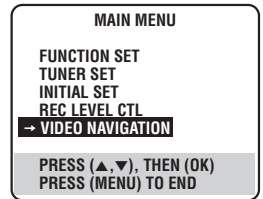

3 Access Find Title screen

Press $\Delta \nabla$ to move the highlight bar (arrow) to "FIND BLANK SPACE", then press **OK** or \triangleright .

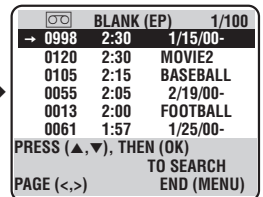

The tape number list screen appears, being sorted by the remaining time (from the longest to the shortest).

4 Confirm tape number lists

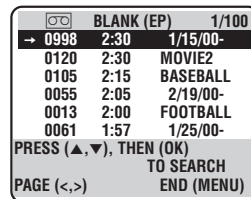

- To go to another page of the lists, press $\triangleleft \triangleright$.

5 Select tape number

Press $\Delta \nabla$ then press **OK**.

- If the tape of the selected tape number is already loaded, the VCR will start searching the beginning of unrecorded portion on that tape (Search Mode).

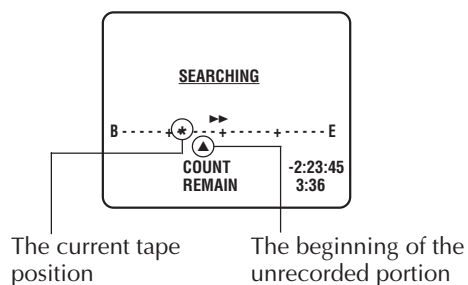

- If the tape of a different tape number is loaded, the VCR will eject the tape, and show the tape number you have selected.



When you insert a tape of the selected tape number, the VCR will start searching the beginning of unrecorded portion on that tape (Search Mode).

Useful Function Settings

Turn on the VCR and the TV, and select the VCR channel 3 or 4 (or AV mode) on the TV.

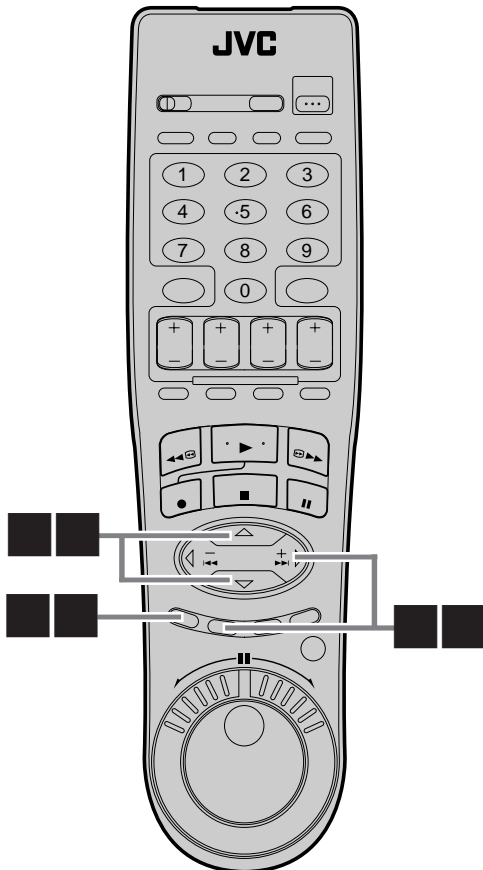
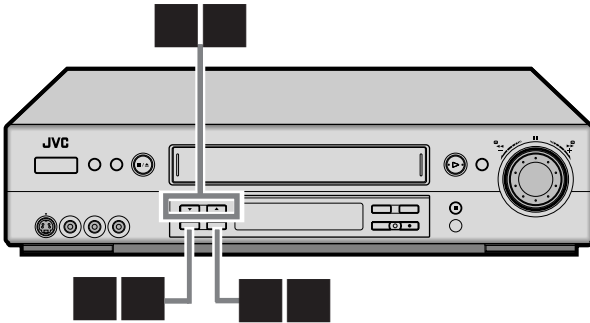

You can use the other useful function settings on the Function Set screen by following the procedure described below.

- For the functions you can set on the Function Set screen, see pages 57 to 60.

Access Main Menu screen

Press **MENU**.

Access Function Set screen

On the front panel:

Press **CH▲▼** to move the highlight bar (arrow) to "FUNCTION SET", then press **OK**.

On the Remote:

Press **▲▼** to move the highlight bar (arrow) to "FUNCTION SET", then press **OK** or **▷**.

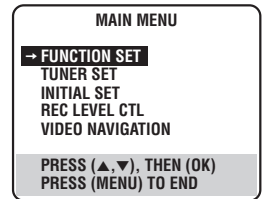

Select Function.

On the front panel:

Press **CH▲▼** to move the highlight bar (arrow) to the function you want to set.

On the Remote:

Press **▲▼** to move the highlight bar (arrow) to the function you want to set.

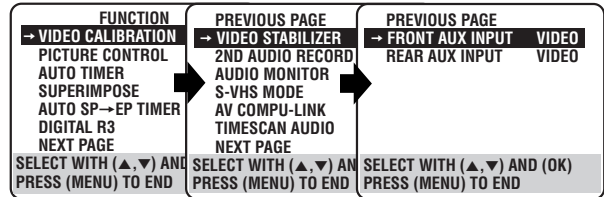

Change setting

On the front panel:

Press **OK**.

On the Remote:

Press **OK** or **▷**.

Return to normal screen

Press **MENU**.

* The default setting is **bold** in the table below.

<p>■ VIDEO CALIBRATION ON OFF</p>	<p>When this function is set to "ON", this VCR checks the condition of the tape in use during playback and recording, and compensates to provide the highest-possible pictures. This takes place whenever you play back a tape or start recording after inserting a tape.</p> <p>NOTES:</p> <ul style="list-style-type: none"> • During playback, this function is always working even though "VIDEO CALIBRATION" appears just at the beginning of automatic tracking. • During recording, this function works only for the first EP recording and the first SP recording on an inserted tape. For timer recording, this function checks the tape condition both for the SP recording and the EP recording before the first timer recording starts. • When you play back rental tapes or tapes recorded on other VCRs, set this function either "ON" or "OFF" whichever gives you the best picture.
<p>■ PICTURE CONTROL AUTO (NORM): Normally select this. Picture quality is adjusted automatically. When "VIDEO CALIBRATION" is "OFF", "NORM" will appear instead of "AUTO". EDIT: Minimizes picture degradation during editing (recording and playback). SOFT: Reduces image coarseness when viewing overplayed tapes containing much noise. SHARP: Clearer, sharper-edged picture when viewing images with much flat, same-colored surfaces such as cartoons.</p>	<p>This function helps you to adjust the playback picture quality according to your preference.</p> <p>NOTES:</p> <ul style="list-style-type: none"> • When you select "EDIT", "SOFT" or "SHARP", the selected mode will not change until you select again. • Select "EDIT" when you are editing tapes (☞ pg. 65, 66, and 69). After you finish editing the tapes, select "AUTO" ("NORM" when "VIDEO CALIBRATION" is "OFF".)
<p>■ AUTO TIMER ON OFF</p>	<ul style="list-style-type: none"> • When this function is set to "ON": The timer recording standby mode is automatically engaged when the VCR is turned off. It is temporarily canceled when the VCR is turned on. You do not have to press TIMER to engage or disengage the timer recording standby mode. • When this function is set to "OFF": You have to press TIMER to engage or disengage the timer recording standby mode.
<p>■ SUPERIMPOSE ON OFF</p>	<p>When this function is set to "ON", various VCR status information (on-screen display) appears on the screen.</p> <p>NOTES:</p> <ul style="list-style-type: none"> • When you use this VCR as the playback VCR for editing a tape, be sure to set this function to "OFF"; otherwise, the VCR status information (on-screen display) will be recorded on the edited tape. • If you select a channel on which no signal is received, the channel number is displayed regardless of this function setting.

* The default setting is **bold** in the table below.

<p>■ AUTO SP → EP TIMER ON OFF</p>	<p>When this function is set to "ON", the VCR automatically switches to EP mode to allow complete recording if there is not enough tape to record the entire program while timer-recording in SP mode. For Example . . . Recording a program of 140 minutes in length onto a 120-minute tape</p> <table border="1" data-bbox="583 357 1173 421"> <tr> <td style="text-align: center;">Approximately 110 minutes</td> <td style="text-align: center;">Approximately 30 minutes</td> </tr> <tr> <td style="text-align: center;">SP mode</td> <td style="text-align: center;">EP mode</td> </tr> </table> <p>Make sure you set this function to "ON" before the timer-recording starts.</p> <p>NOTES:</p> <ul style="list-style-type: none"> ● If you have programmed the VCR to timer-record 2 or more programs, the second program and those thereafter may not fit on the tape with this function set to "ON". In this case, do not use this function, but change the tape speed manually during timer programming. ● In order to ensure that the recording fits on the tape, this function may leave a slight non-recorded portion at the end of the tape. ● There may be some noise and sound disturbance where the tape speed switches from SP to EP mode on the tape. ● This function is not available during ITR (Instant Timer Recording), and will not work properly on the following tapes: T(ST)-30, T(ST)-60, T(ST)-90, and T(ST)-120. 	Approximately 110 minutes	Approximately 30 minutes	SP mode	EP mode
Approximately 110 minutes	Approximately 30 minutes				
SP mode	EP mode				
<p>■ DIGITAL R3 ON OFF</p>	<p>When this function is set to "ON", edge correction to the luminance signal is performed to enhance details. Normally set this function to "ON".</p> <p>NOTES:</p> <ul style="list-style-type: none"> ● Depending on the type of tape being used, picture quality may be better with "DIGITAL R3" set to "OFF". ● If you use this VCR as the playback VCR for editing, be sure to set "DIGITAL R3" to "OFF" before starting. 				
<p>■ VIDEO STABILIZER ON OFF</p>	<p>When this function is set to "ON", you can automatically correct vertical vibrations in the picture when playing back unstable recordings made on another VCR.</p> <p>NOTES:</p> <ul style="list-style-type: none"> ● When you finish viewing a tape, be sure to set this function to "OFF". ● Regardless of the setting, this function has no effect during recording and during special effects playback. ● The on-screen display may jitter vertically when this function is set to "ON". ● To watch recordings with close-caption, set this function to "OFF". ● Video Stabilizer and Digital TBC/NR cannot be used at the same time. If you activate Digital TBC/NR when "VIDEO STABILIZER" is set to "ON", Video Stabilizer will be automatically turned "OFF". 				
<p>■ 2ND AUDIO RECORD ON OFF</p>	<p>When this function is set to "ON";</p> <ul style="list-style-type: none"> ● If a SAP program is received, the SAP audio is recorded on both the normal and Hi-Fi tracks. The main audio is not recorded. ● If a non-SAP program is received, the main audio is recorded on both the Hi-Fi and normal tracks. <p>When this function is set to "OFF", the SAP audio cannot be recorded.</p>				

* The default setting is **bold** in the table below.

<p>■ AUDIO MONITOR</p> <p>HI-FI: Normally select this. Hi-Fi sound is played back.</p> <p>HI-FI L: Sound on the left Hi-Fi channel is played back.</p> <p>HI-FI R: Sound on the right Hi-Fi channel is played back.</p> <p>NORM: Sound on the normal track is played back.</p> <p>MIX: Both sounds on the Hi-Fi track and normal track are mixed and played back.</p>	<p>This VCR can record two sound tracks simultaneously (normal and Hi-Fi) on a Hi-Fi stereo tape.</p> <p>You can select the sound track(s) to listen to while playing back a Hi-Fi stereo tape.</p> <p>In addition, when playing back a prerecorded tape containing two separate audio programs on the Hi-Fi tracks, you can choose either one by selecting either "HI-FI L" or "HI-FI R".</p> <p>NOTES:</p> <ul style="list-style-type: none"> • While playing back a monaural tape, sounds on the normal track will be heard regardless of this setting. • If RF connection (☞ pg. 7) is used for viewing pictures on the TV, sound will be monaural even though you select "HI-FI". • You can also use the A. MONITOR button on the Remote to select the desired monitor sound. (☞ pg. 25)
<p>■ S-VHS MODE</p> <p>ON</p> <p>OFF</p>	<p>You can determine which recording mode — either S-VHS mode or VHS mode — is used for recording on S-VHS tapes.</p> <p>When this function is set to "ON", you can record on S-VHS tapes with S-VHS picture quality.</p> <p>When this function is set to "OFF", you can record on S-VHS tapes with VHS picture quality.</p> <p>NOTES:</p> <ul style="list-style-type: none"> • S-VHS mode allows you to make high quality video recordings with horizontal resolution of 400 lines, comparing with the 230 lines of resolution of conventional VHS recordings. To achieve the highest quality picture we recommend to record in S-VHS mode. (But remember that a conventional VHS VCR without SQPB cannot play back S-VHS tapes recorded in S-VHS mode.) • S-VHS MODE setting does not affect recording on VHS tapes. Recording on VHS tapes is always performed in VHS mode except when using S-VHS ET mode (☞ pg. 31).
<p>■ AV COMPU-LINK</p> <p>ON</p> <p>OFF</p>	<p>The REMOTE PAUSE/AV COMPULINK terminal on the rear panel can be used as either the REMOTE PAUSE terminal or the AV COMPULINK terminal.</p> <p>When this function is set to "ON", you can use this terminal as the AV COMPULINK terminal.</p> <p>By connecting other JVC's AV COMPULINK components (see the diagram on the next page), including amplifiers (or receivers) and televisions, one touch control of the audio and video components linked via their AV COMPULINK connectors becomes possible.</p> <p>For example: simply load a cassette in the VCR and press PLAY (▶) so that the AV COMPULINK components automatically turn on, the TV's AV mode is selected and the VCR starts playback. (You do not have to press PLAY (▶) if the cassette's record safety tab is removed.)</p> <p>When this function is set to "OFF", you can use this terminal as the REMOTE PAUSE terminal. (☞ pg. 65)</p> <p>NOTE:</p> <p>Connection varies depending on the type of JVC TV you have. Refer to the TV's instruction manual when making this connection.</p> <p style="text-align: right;">CONTINUED ON NEXT PAGE ➔</p>

* The default setting is **bold** in the table below.

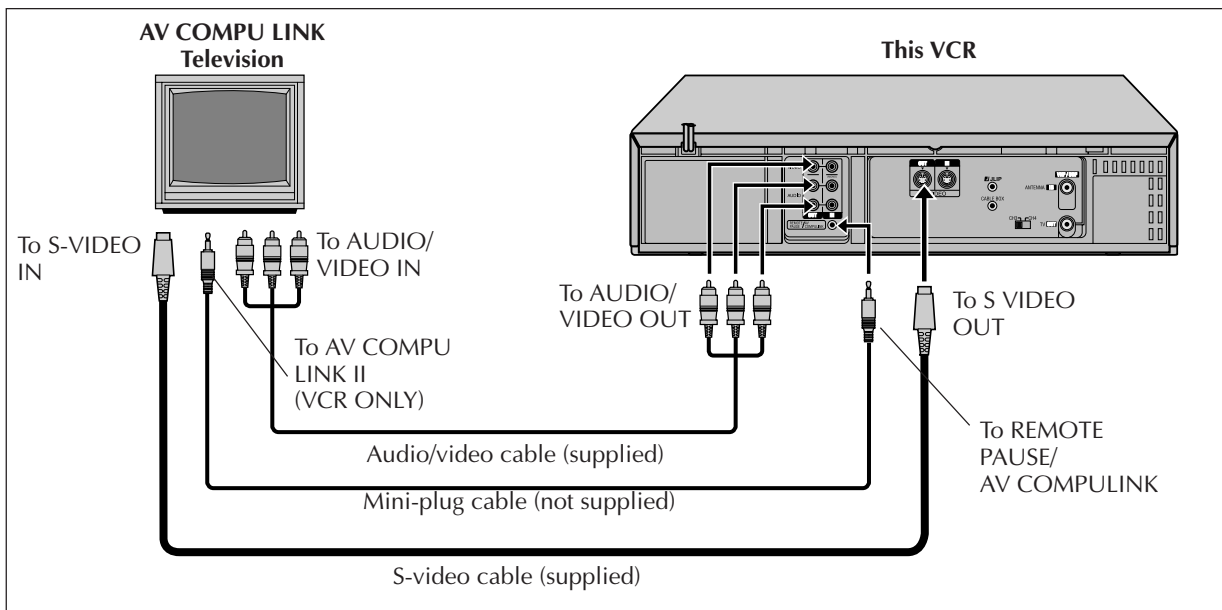

■ TIMESCAN AUDIO

ON
OFF

The TimeScan function enables this VCR to reproduce noiseless pictures and sounds during special effect playback (see pg. 34 – 37). However, the sounds you hear are monaural, and are not the same as original sounds recorded on the tape.

If you do not want to hear the sounds during special effect playback with TimeScan, set "TIMESCAN AUDIO" to "OFF" so that the sounds will not be heard during special effect with TimeScan.

- For more about the TimeScan function, see page 37.

■ FRONT AUX INPUT

VIDEO
S-VIDEO

You have to select which terminal — either VIDEO (composite) or S-VIDEO (Y/C separate signals) to use as the video input terminal on the front panel.

Make sure to select the correct terminal; otherwise, you may fail in recording (editing) on this VCR.

■ REAR AUX INPUT

VIDEO
S-VIDEO

You have to select which terminal — either VIDEO (composite) or S-VIDEO (Y/C separate signals) to use as the video input terminal on the rear panel.

Make sure you select the correct terminal; otherwise, you may fail in recording (editing) on this VCR.

Satellite Auto Recording

This function allows you to automatically record a satellite program which is timer-programed on your DBS receiver.

Preparation: Connect a DBS receiver to the AUDIO/VIDEO IN or S VIDEO IN (L-1) connectors* on the rear; otherwise, you cannot use this function.

• You can also connect the cable box if it has a timer.

* To use these connectors, you have to select which one to use (☞ pg. 60).

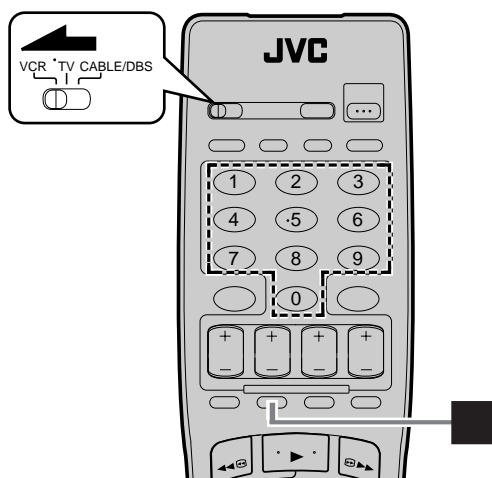
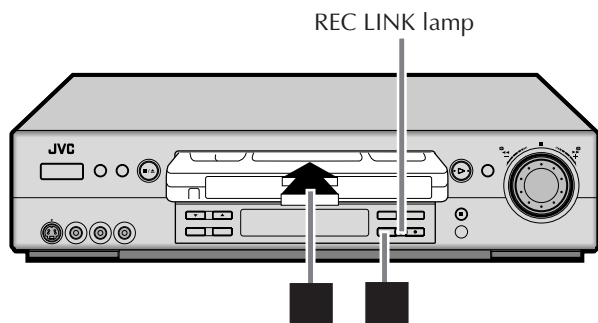

Set timer program on DBS receiver

• For timer programing method, refer to the manual supplied with the DBS receiver.

Load a cassette

Make sure the record safety tab is intact.

Set tape speed

Press **SP/EP** () to set the recording speed.

Engage Satellite Auto Recording standby mode

Press **REC LINK**.

The VCR turns off automatically and the REC LINK lamp lights (Satellite Auto Recording standby mode).

When signals come into the VCR from the DBS receiver, the VCR starts recording (the REC LINK lamp blinks), and stops recording and goes off when signals stop coming in.

• Each time you press the button, Satellite Auto Recording standby mode turns on and off. When it is off, the REC LINK lamp goes off.

IMPORTANT: Be sure not to turn on the DBS receiver before the program starts broadcasting; otherwise, the VCR will start recording when the DBS receiver is turned on.

NOTES:

- While the Satellite Auto Recording standby mode or after Satellite Auto Recording is finished, the VCR will not enter the timer recording standby mode even though "AUTO TIMER" is set to "ON". (☞ pg. 57)
- If you turn off this VCR while Satellite Auto Recording is in progress, recording stops.
- Video Calibration (☞ pg. 57) does not work while Satellite Auto Recording is in progress.
- Auto Clock (☞ pg. 11) does not work while in the Satellite Auto Recording standby mode.
- The VCR may not record a short portion at the beginning of the program or may record slightly longer than the actual length of the program when Satellite Auto Recording method is used.
- If you engage the Satellite Auto Recording standby mode while the DBS receiver is turned on, the VCR will not start Satellite Auto Recording even though the REC LINK lamp blinks. When you turn off and on the DBS receiver once again, the VCR starts recording.
- If you have connected another component other than a DBS receiver (or cable box) to the AUDIO/VIDEO IN or S VIDEO IN (L-1) connectors, be sure not to engage the Satellite Auto Recording standby mode; otherwise, the VCR will start recording when the connected component is turned on.
- Satellite Auto Recording and timer-recording cannot be performed at the same time.
- If the REC LINK lamp does not light but blinks quickly in the Satellite Auto Recording standby mode (even though your DBS receiver is turned off), Satellite Auto Recording will not work properly. If this is the case, perform "Express Timer Programing" (☞ pg. 42) to timer-record a satellite program. (Some DBS receivers output signals even if the power is off. Satellite Auto Recording is not possible with those DBS receivers.)

Child Lock

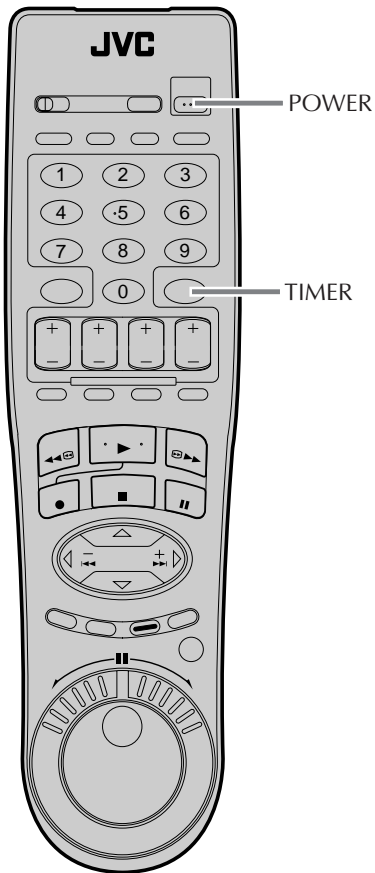

You can disable the VCR operations.

- You can only use the Remote for this operation.

While the VCR is turned on, press and hold POWER on the Remote for more than seven seconds.

The VCR turns off, and the child lock indicator appears on the front display panel.



- The child lock function is now activated and you cannot turn on the VCR by pressing **POWER** on the front panel.

To release the child lock, press and hold **POWER** on the Remote until the VCR turns on.

- During timer recording, pressing **TIMER** also releases the child lock.

NOTES:

- When the child lock function is in use, keep the Remote out of the children's reach.
- Timer recording programs will be performed even if the child lock function is activated.

JLIP ID Number Setting

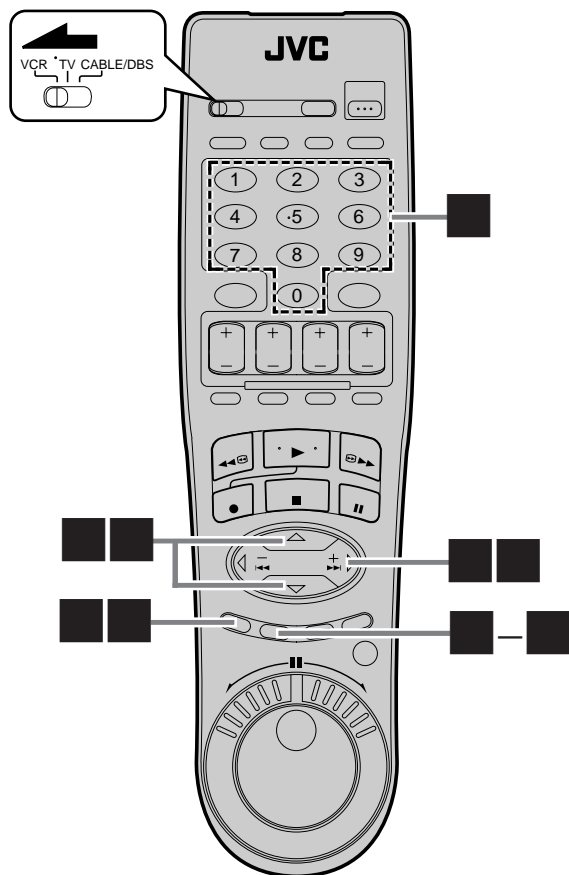
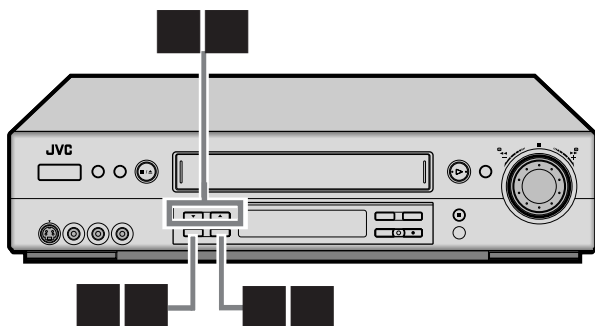

The JLIP (Joint Level Interface Protocol) terminal is used to connect the VCR to a personal computer or similar device. By connecting through the JLIP terminals, you can control the VCR during editing and certain other operations, from the connected personal computer or similar device.

When connecting this VCR to another device using the JLIP terminals, each device must have a different JLIP ID number.

The JLIP ID number of this VCR is preset to "1" when shipped from the factory. You can change this number to any other number between 1 to 99.

To change the JLIP ID number of this VCR, follow the procedure below.

Access Main Menu screen

Press **MENU**.

Access Initial Set screen

On the front panel:

Press **CH▲▼** to move the highlight bar (arrow) to "INITIAL SET", then press **OK**.

On the Remote:

Press **▲▼** to move the highlight bar (arrow) to "INITIAL SET", then press **OK** or **▷**.

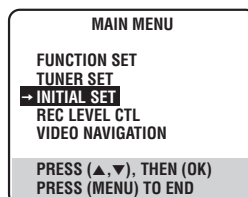

Select JLIP ID Number Set screen

On the front panel:

Press **CH▲▼** to move the highlight bar (arrow) to "JLIP ID NO. SET", then press **OK**.

On the Remote:

Press **▲▼** to move the highlight bar (arrow) to "JLIP ID NO. SET", then press **OK** or **▷**.

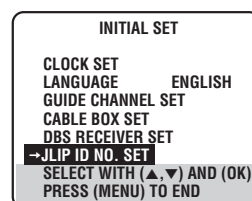

Set JLIP ID Number

On the Remote ONLY:

Press the **Number** keys to enter the desired ID number, then press **OK**.

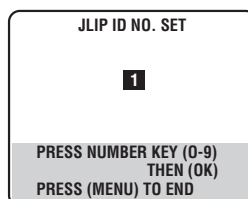

Return to normal screen

Press **MENU**.

NOTE:

For further details on the JLIP system or devices, consult your nearest JVC dealer.

U.S. customers can contact JVC directly toll free at 1-800-252-5722.

Edit From Camcorder

Connection

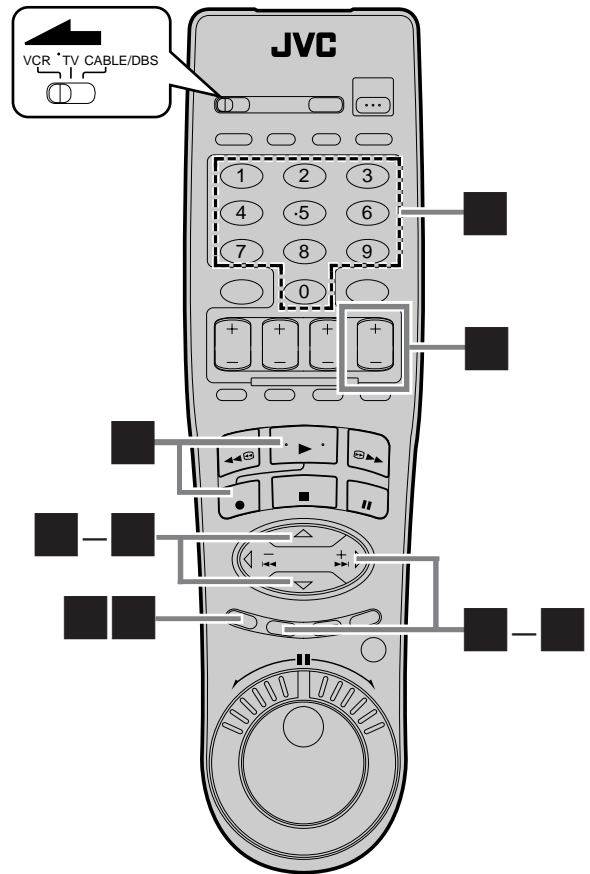
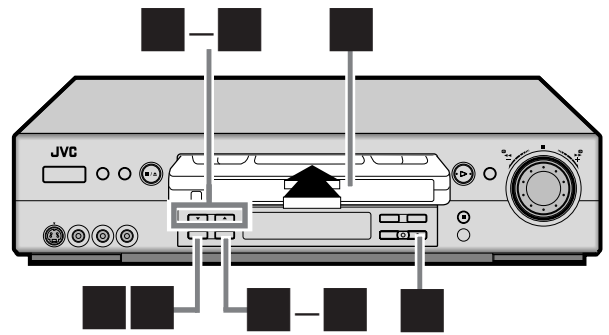
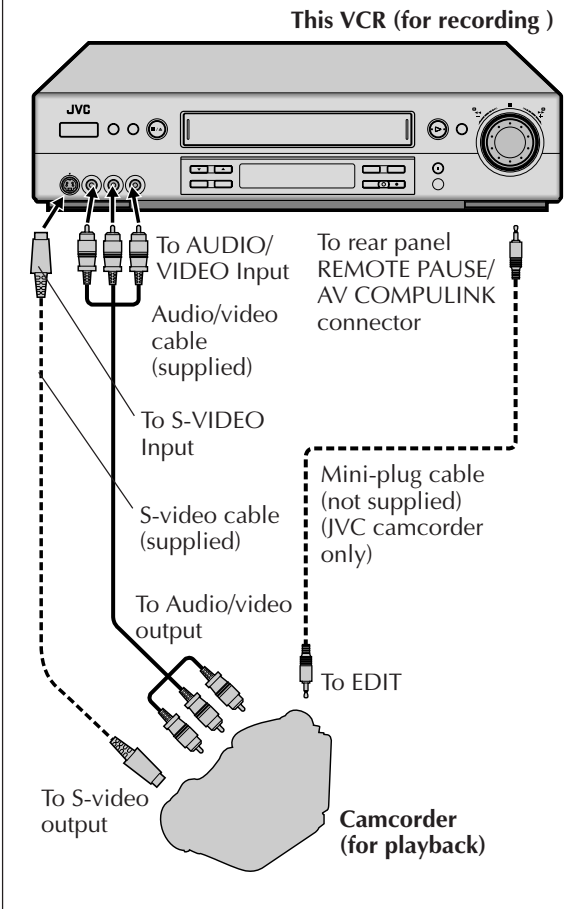

Various connection for editing tapes

The following three methods can be used for editing tapes.

- VHS to S-VHS editing (VIDEO-VIDEO connection):**
 Although the picture quality is inherently limited by the original VHS quality, the edited tape has better picture quality than those made by VHS-to-VHS editing.
- S-VHS to VHS editing (VIDEO-VIDEO connection):**
 Since the original source is recorded in S-VHS mode, the edited tape has better picture quality than those made by VHS-to-VHS editing.
- S-VHS to S-VHS (S-VIDEO connection):** Original picture quality of S-VHS made can be duplicated with minimal picture degradation. This is the best editing method you can use on S-VHS VCRs.

You can use a camcorder as the playback VCR and your VCR as the recording VCR.

Make connections

Connect an audio/video cable between the camcorder's audio/video output connectors and your VCR's audio/video input connectors.

- When the JVC camcorder is equipped with the Master Edit Control, you can control the VCR from the camcorder. Connect the mini-plug cable (not supplied with this VCR) as illustrated to the left.
- When using a camcorder with a monaural output, connect the audio output connector on the camcorder to the left audio input connector on this VCR.

Load a cassette

Insert the cassette to be recorded on into this VCR (for recording).

Select input mode on this VCR

Select "L-1" — when connecting the camcorder to the audio/video input connectors on the rear panel.

Select "F-1" — when connecting the camcorder to the audio/video input connectors on the front panel.

On the front panel:

Press CH▲▼.

On the Remote:

Press the **Number** key "0 (AUX)" or CH +/-.

Select video input terminal

Follow steps ■ to ■ described on pages 56.

When using S VIDEO terminal, set "FRONT AUX INPUT" (or "REAR AUX INPUT" if you use the connectors on the rear) to "S-VIDEO".

When using VIDEO terminal, set "FRONT AUX INPUT" (or "REAR AUX INPUT") to "VIDEO".

Set "PICTURE CONTROL" to "EDIT"

Follow steps ■ and ■ described on pages 56.

If your camcorder is a JVC Master Edit Control-equipped type — go to step ■.

If your camcorder is NOT a JVC Master Edit Control-equipped type — go to step ■.

Set "AV COMPU-LINK" to "OFF"

Follow steps ■ and ■ described on pages 56.

- The REMOTE PAUSE/AV COMPULINK connector works as the Remote Pause connector when "AV COMPU-LINK" is set to "OFF".

Return to normal screen

Press MENU.

Start playback

Press PLAY (▶) on the camcorder.

NOTE:

If the camcorder is equipped with a superimpose/OSD disable feature then set it to "OFF" before starting playback.

Start recording

On the front panel:

Press REC (●).

On the Remote:

Press REC (●) and PLAY (▶) at the same time.

- If you are using a Master Edit Control-equipped JVC camcorder, recording starts automatically on this VCR. (Refer to camcorder's instruction manual.)

NOTE:

Be sure to select "AUTO" for "PICTURE CONTROL" (or "NORM" when "VIDEO CALIBRATION" is set to "OFF") after you finish dubbing the tapes (☞ pg. 56 and 57).

Edit To Or From Another VCR

Connection

Ex. When using this VCR as the playback VCR

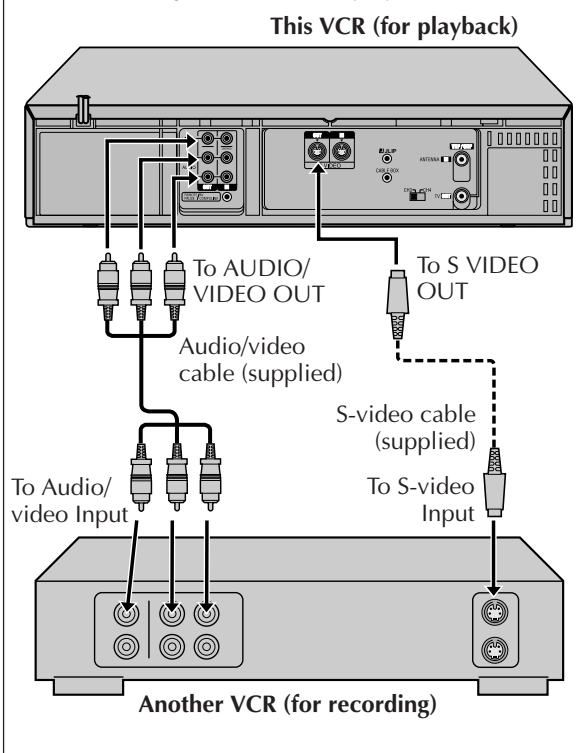

You can use your VCR as the playback or recording VCR.

- Refer also to the other VCR's instruction manual for connection and its operations.

Make connections

Connect an audio/video cable between the playback VCR's audio/video output connectors and the recording VCR's audio/video input connectors.

- When using this VCR as the recording VCR, connect this VCR's audio/video input connectors to the audio/video output connectors on the other VCR. If the playback VCR is monaural, connect the audio output connector on the playback VCR to the left audio input connector on this VCR.

Load cassettes

Insert the playback cassette into the playback VCR and the cassette to be recorded on into the recording VCR.

Select input mode on recording VCR

Select the correct external input on the other VCR.

- On this VCR (when using this VCR as the recording VCR);
Select "L-1" — when connecting the other VCR to the audio/video input connectors on the rear panel.
Select "F-1" — when connecting the other VCR to the audio/video input connectors on the front panel.

On the front panel:

Press **CH▲▼**.

On the Remote:

Press the **Number** key "0 (AUX)" or **CH +/-**.

NOTES:

- When using this VCR as the recording VCR, set the video input terminal setting correctly (☞ pg. 56 and 60).
- When using this VCR as the playback VCR for editing, set "DIGITAL R3" to "OFF" (☞ pg. 58).

Select edit mode

Set the edit mode to "ON" for the VCRs if such a mode is equipped.

- On this VCR, set "PICTURE CONTROL" to "EDIT" by following the procedure described on pages 56 and 57.

Start playback

Press **PLAY (▶)** on the playback VCR.

NOTE:

If the playback VCR is equipped with a superimpose/OSD disable feature then set it to "OFF" before starting playback (☞ pg. 56 and 57).

Start recording

Press **REC (●)** on the recording VCR.

NOTE:

Be sure to select "AUTO" for "PICTURE CONTROL" (or "NORM" when "VIDEO CALIBRATION" is set to "OFF") after you finish dubbing the tapes (☞ pg. 56 and 57).

Audio Dubbing

Connection

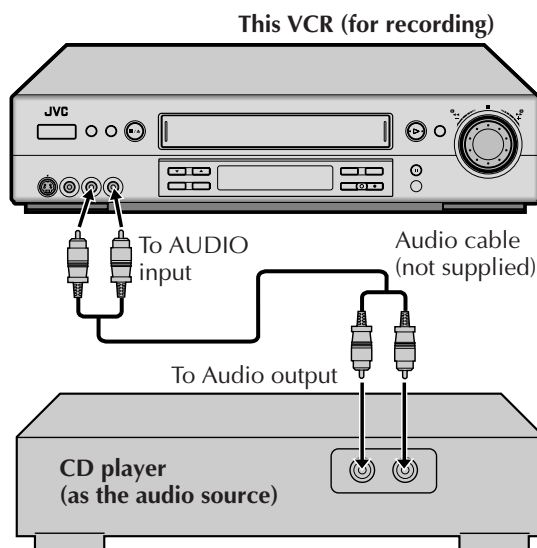

- Audio Dubbing is also possible using the audio input connectors on the rear panel.

You can replace sounds recorded on the normal track with new sounds — for example, your favorite song played back on the CD player.

- Refer also to the other audio component's instruction manual for connection and its operations.

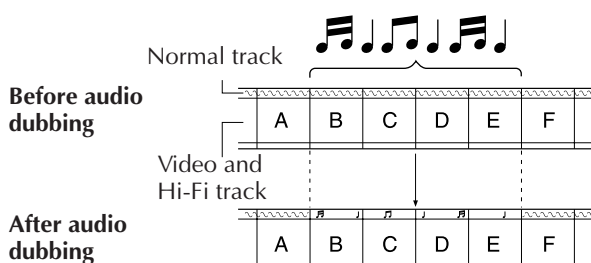

Make connections

Connect an audio cable between the VCR's audio input connectors and the audio component's audio output connectors.

- If the audio component is monaural, connect the AUDIO L (MONO) input connector on the VCR.

Load a cassette and prepare the audio source

Select input mode

Select "F-1" — when connecting the audio component to the audio input connectors on the front panel.

Select "L-1" — when connecting the audio component to the audio input connectors on the rear panel.

On the front panel:

Press **CH▲▼**.

On the Remote:

Press the **Number** key "0 (AUX)" or **CH +/-**.

Locate start point

- 1 Press **PLAY** (▶) to start playback.
- 2 Press **PAUSE** (⏸) when you find the beginning of the scene for which you want to audio-dub.

Activate Audio Dubbing mode

Press **A. DUB** on the front panel.

- The VCR enters the Audio Dubbing pause mode.
- blinks, and light up on the front display panel.

Start audio dubbing

Press **PLAY** (▶) on this VCR and start playing the audio source.

- blinks and is displayed on the front display panel.

To stop audio dubbing

Press **STOP** (■) on the Remote or **STOP/EJECT** (■/▲) on the front panel.

- Audio dubbing automatically stops when the counter reading becomes "0:00:00", and the VCR starts normal playback.

NOTES:

- During Audio Dubbing, the sound recorded on the normal track is selected as the monitor sound. If you want to listen to the Hi-Fi or mixed sound (Hi-Fi sound and monaural sound), see "Selecting monitor sound — Audio Monitor" (⌚ pg. 25).
- Audio Dubbing cannot be performed on a tape with its record safety tab removed.
- When playing back an audio-dubbed tape, select the sound you want. See "Selecting monitor sound — Audio Monitor" (⌚ pg. 25).
- Picture may be distorted if you pause Audio Dubbing.

Insert Editing and AV Dubbing

Refer also to the other component's instruction manual for connection and its operations.

Insert Editing: You can replace a recorded scene with new scene recorded on another tape or with other material. Both the picture and the sound recorded on the Hi-Fi sound track are replaced at the same time.

Audio/Video Dubbing: You can perform Audio Dubbing and Insert Editing at the same time. This means that the picture and the sounds recorded on the Hi-Fi sound track and on the normal track are replaced at the same time.

- For Audio/Video Dubbing, you can edit pictures and sound using different sources; connect a video source to the video input connector, and an audio source to the audio input connectors.

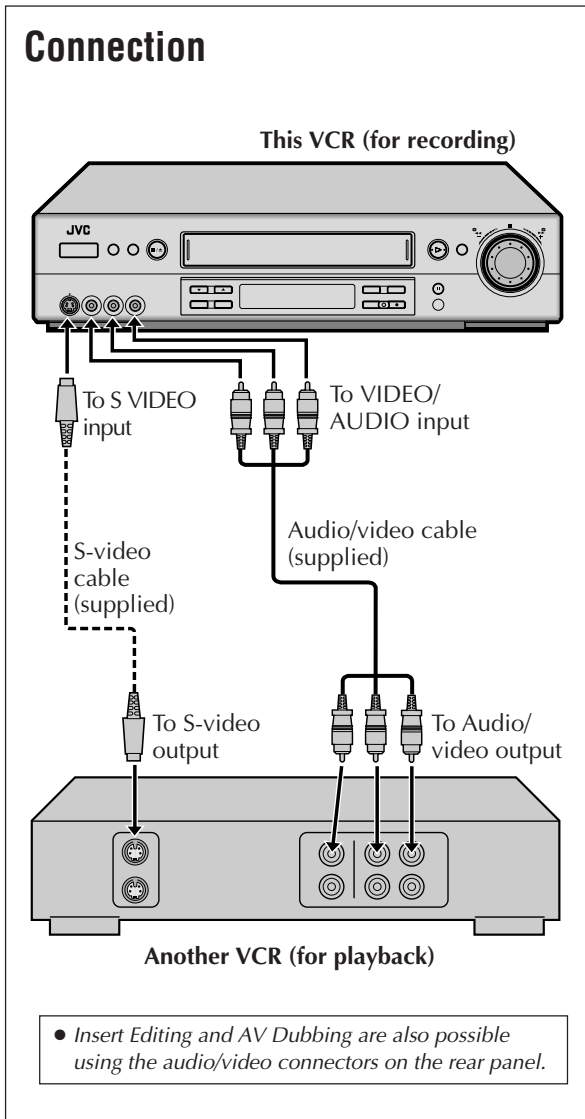

Insert Editing

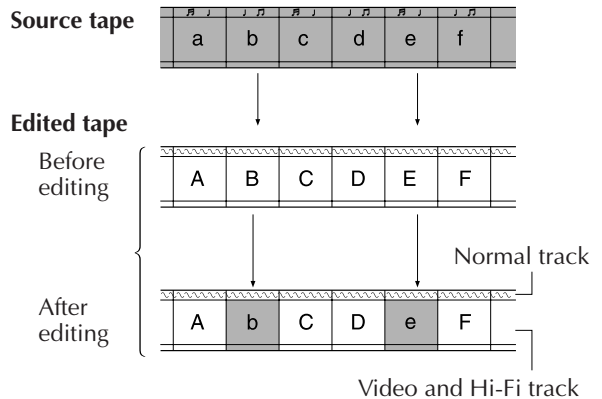

AV Dubbing

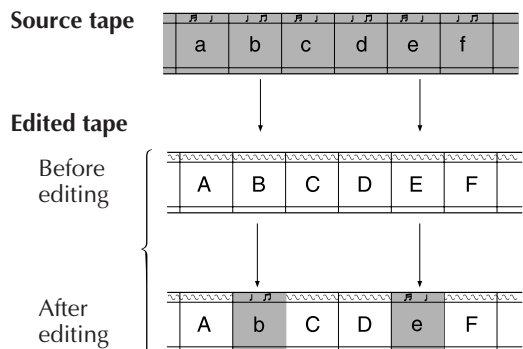

Make connections

Connect an audio/video cable between the VCR's audio/video input connectors and the other component's audio/video output connectors.

Prepare tapes

Load the source tape on the other VCR, and the tape to be edited on this VCR.

Select input mode

Select "F-1" — when connecting the other component to the audio/video input connectors on the front panel.

Select "L-1" — when connecting the other component to the audio/video input connectors on the rear panel.

On the front panel:

Press **CH▲▼**.

On the Remote:

Press the **Number** key "0 (AUX)" or **CH +/-**.

Select video input terminal

Follow the procedure described on pages 56 and 60.

When using S VIDEO terminal, set "FRONT AUX INPUT" (or "REAR AUX INPUT" if you use the connectors on the rear) to "S-VIDEO".

When using VIDEO terminal, set "FRONT AUX INPUT" (or "REAR AUX INPUT") to "VIDEO".

Select edit mode

Set the edit mode to "ON" for the VCRs if such a mode is equipped.

- On this VCR, set "PICTURE CONTROL" to "EDIT" by following the procedure described on pages 56 and 57.

Locate end point

- 1 Press **PLAY** (▶) to start playback.
- 2 Press **PAUSE** (⏸) when you find the end of the scene for which you want to edit.
- 3 Press **C. RESET** so that the counter reading becomes "0:00:00".

NOTE:

You can also use **FF** (⏮), the **TIME SCAN SHUTTLE** ring on the front panel, and the **JOG/SHUTTLE** ring on the Remote to locate the end point (See "Special Effect Playback": Ⓞ pg. 34).

Locate start point

Use **REW** (⏮), the **TIME SCAN SHUTTLE** ring on the front panel, or **JOG/SHUTTLE** ring on the Remote to reverse the tape. (See "Special Effect Playback": Ⓞ pg. 34.)

When you find the beginning of the scene you want to edit, press **PAUSE** (⏸).

Activate editing mode

For Inset Editing:

Press **INSERT** on the front panel.

For AV Dubbing:

Press **INSERT**, then press **A. DUB** on the front panel.

- Make sure that the recording format (VHS, S-VHS or S-VHS ET) on the VCR is the same as that of the original recording on the tape.
- During Inset Editing pause mode (⦿, ▶ and ⏮ light up on the front display panel.)
- During AV Dubbing pause mode (⦿ and ▶ blink, and ⏮ lights up on the front display panel.)

Start editing

Press **PLAY** (▶) on this VCR, and start playback on the other component at the same time.

- During Inset Editing mode (⦿ and ▶ light up on the front display panel.)
- During AV Dubbing mode (⦿ and ▶ blink on the front display panel.)
- When the counter reading becomes "0:00:00", editing automatically stops, and the VCR starts normal playback.

To stop editing any time during recording

Press **STOP** (■) on the Remote or **STOP/EJECT** (■ / ▲) on the front panel.

NOTES:

- Be sure to select "AUTO" for "PICTURE CONTROL" (or "NORM" when "VIDEO CALIBRATION" is set to "OFF") after you finish editing the tapes (Ⓞ pg. 56 and 57).
- Editing cannot be performed on a tape with its record safety tab removed.
- The recording speed (SP/EP) is determined by the previous recording to be replaced. If the recording speed changes on the tape to be edited while editing the tape, the inserted picture will be distorted where the recording speed changes.
- When you edit a tape, a small portion of the recording preceding to the editing start point will be erased from the edited tape.

TV Brand Setting

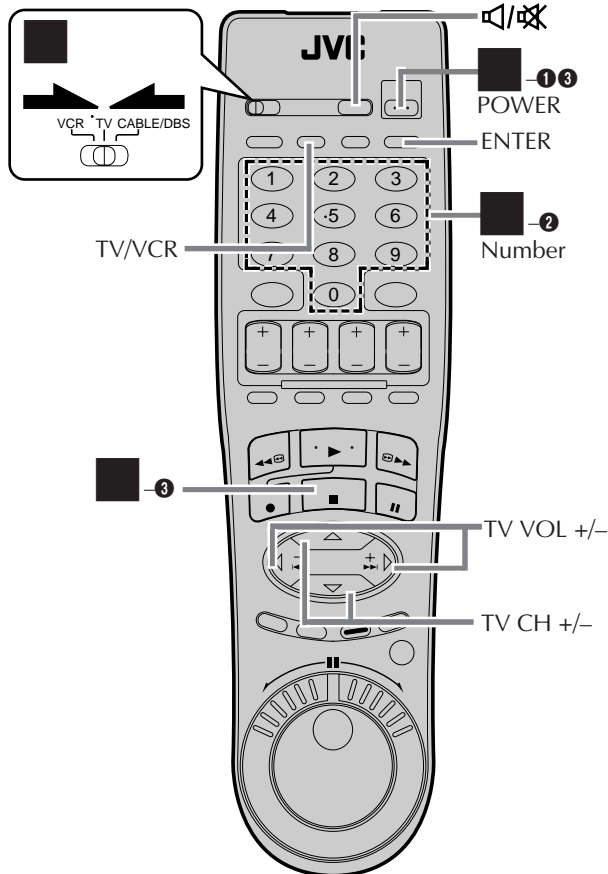

This Remote can control some functions of remote controllable TVs listed below. Without setting, you can control a JVC TV.

Turn on the TV

Turn on the TV using the Power button on the TV or its Remote.

Set remote operation mode

Set the **VCR/TV/CABLE/DBS** selector to "TV".

Set TV brand code

Follow the example shown below.

- ① Press and hold **POWER**.
- ② Press the **Number** keys to enter your TV's brand code by referring to the table below.
- ③ Press **STOP** (■), and release **POWER**.

- Once you have set the Remote to operate the TV, you do not have to set it until you replace the batteries from the Remote.
- PANASONIC has two codes. If the TV does not function with one code, try entering the other.

Operate TV

First set the **VCR/TV/CABLE/DBS** selector to "TV", then press one of the following buttons: **POWER**, **TV/VCR**, **TV CH +/-**, **TV Muting** (TV Muting), **TV VOL +/-**, and **Number** keys.

- For some brands, you must press **ENTER** after having pressed the **Number** keys to enter a channel number.
- To operate the VCR, set the **VCR/TV/CABLE/DBS** selector back to "VCR".

NOTES:

- Depending on the type of TV, some or all functions cannot be operated using this Remote.
- It's not possible to operate a TV not equipped with a remote sensor.

TV BRAND NAME	BRAND CODE
JVC	01, 03
HITACHI	10
MAGNAVOX	02
MITSUBISHI	03
PANASONIC	04, 11
RCA	05
SHARP	06
SONY	07
SAMSUNG	12
SANYO	13
SEARS	13
TOSHIBA	08
ZENITH	09

(Ex.) To set Remote to RCA 05:

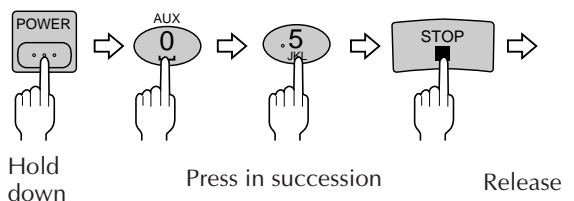

Cable Box Brand Setting

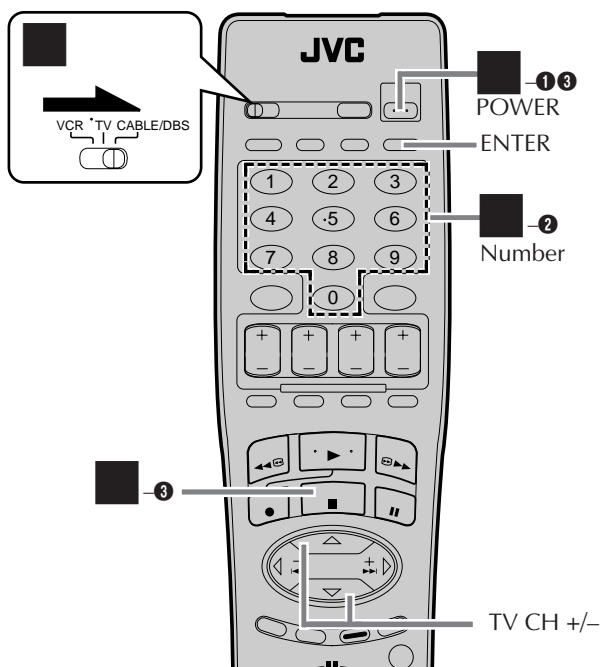

This Remote can control some functions of the cable boxes listed below. Some cable box brands have more than one code. If your cable box does not function with a specified code, try other codes.

Turn on the cable box

Turn on the cable box using the Power button on the cable box or its Remote.

Set remote operation mode

Set the **VCR/TV/CABLE/DBS** selector to "CABLE/DBS".

Enter cable box brand code

Follow the example shown below.

- 1 Press and hold **POWER**.
 - 2 Press the **Number** keys to enter your cable box's brand code by referring to the table below.
 - 3 Press **STOP** (■), and release **POWER**.
- Once you have set the Remote to operate the cable box, you do not have to set it until you replace the batteries from the Remote.

Operate cable box

First set the **VCR/TV/CABLE/DBS** selector to "CABLE/DBS", then press one of the following buttons: **POWER**, **TV CH +/-**, and **Number** keys.

- For some brands, you must press **ENTER** after having pressed the **Number** keys to enter a channel number.
- To change the cable box's channels, press **TV CH +/-** or the **Number** keys. (The **CH +/-** button can be used to change the VCR's channels only.)
- To operate the VCR, set the **VCR/TV/CABLE/DBS** selector back to "VCR".

NOTES:

- Depending on the type of cable box, some or all functions cannot be operated using this Remote.
- It's not possible to operate a cable box not equipped with a remote sensor.
- It's not possible to set the Remote for both your cable box and a DBS receiver at the same time. You can only set the Remote control to operate one of these units at a time.

CABLE BOX BRAND NAME	BRAND CODE
ARCHER	01, 05, 17
CABLETENNA	01, 17
CABLEVIEW	15, 16, 17, 21, 25
CITIZEN	15, 16, 17, 21, 25
CURTIS	02
DIAMOND	01, 17
EASTERN	19
GC BRAND	15, 16, 17, 21, 25
GEMINI	15
GENERAL INSTRUMENTS	01, 04, 06, 11, 12, 15, 28
HAMLIN	10, 18, 19, 23
JASCO	15
JERROLD	01, 04, 06, 11, 12, 15, 28
NOVAVISION	02
OAK	07
PANASONIC	13, 14
PULSER	15, 16, 17, 21, 25
RCA	13, 14
REGAL	10, 18, 19, 23
REGENCY	19
REMBRANDT	01, 16, 17
SAMSUNG	05, 16, 24
SCIENTIFIC ATLANTA	02
SIGMA	07
SL MARX	05, 16, 17, 24, 25
SPRUCER	13, 14
STARGATE	05, 15, 16, 17, 21, 24, 25
TELEVIEW	05, 16, 24
TOCOM	01, 04, 16
UNIKA	01, 17
UNIVERSAL	16, 17, 25
VIDEOWAY	03, 09, 22
ZENITH	03, 09, 22

(Ex.) To set the Remote to RCA 14:

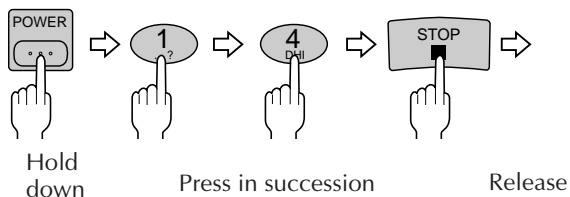

DBS Receiver Brand Setting

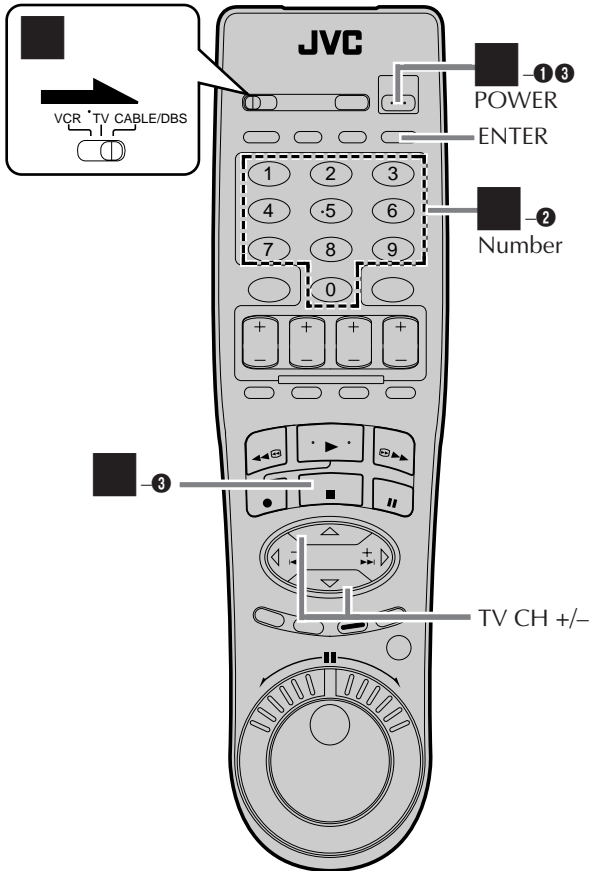

This Remote can control some functions of the DBS (Direct Broadcast Satellite) receivers listed below.

Turn on the DBS receiver

Turn on the DBS receiver using the Power button on the DBS receiver or its Remote.

Set remote operation mode

Set the VCR/TV/CABLE/DBS selector to "CABLE/DBS".

Enter DBS receiver brand code

Follow the example shown below.

1 Press and hold **POWER**.

2 Press the **Number** keys to enter your DBS receiver's brand code by referring to the table below.

3 Press **STOP** (■), and release **POWER**.

• Once you have set the Remote to operate the DBS receiver, you do not have to set it until you replace the batteries from the Remote.

Operate DBS receiver

First set the VCR/TV/CABLE/DBS selector to "CABLE/DBS", then press one of the following buttons: **POWER**, **TV CH +/-**, and **Number** keys.

• For some brands, you must press **ENTER** after having pressed the **Number** keys to enter a channel number.

• To change the DBS receiver's channels, press **TV CH +/-** or the **Number** keys. (The **CH +/-** button can be used to change the VCR's channels only.)

• To operate the VCR, set the VCR/TV/CABLE/DBS selector back to "VCR".

NOTES:

- Depending on the type of DBS receiver, some or all functions cannot be operated using this Remote.
- It's not possible to operate a DBS receiver not equipped with a remote sensor.
- It's not possible to set the Remote for both your DBS receiver and a cable box at the same time. You can only set the Remote to operate one of these units at a time.

DBS BRAND NAME	BRAND CODE
JVC (DISH Network)	51
ECHOSTAR (DISH Network)	51
PRIMESTAR	50
SONY (DSS)	41
RCA (DSS)	40

(Ex.) To set the Remote to JVC 51:

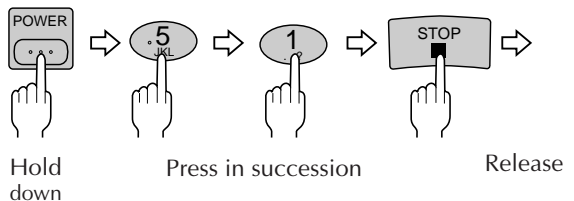

Changing Remote Control Code

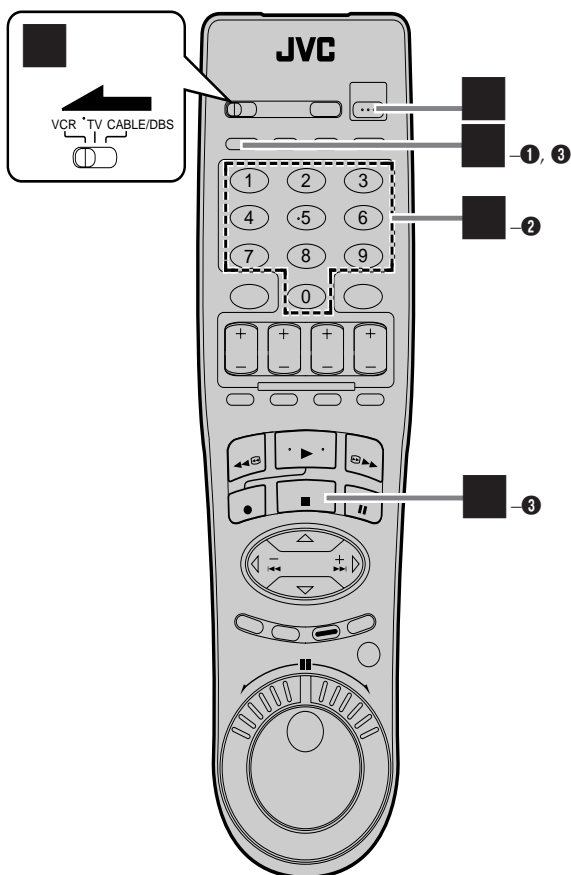

This Remote is capable of transmitting two control codes; one set to respond to A code control signals and another set to respond to B code control signals. This Remote control is preset to send A code signals because your VCR is initially set to respond to A code signals. You can easily modify your VCR and the Remote to respond to B code signals. When using two JVC VCRs, set two VCRs and their Remotes to different codes, so that you can operate these VCRs separately.

Unplug VCR

Unplug the AC power cord from the AC outlet.

Set remote operation mode

Set the **VCR/TV/CABLE/DBS** selector to "VCR".

Set remote control code for Remote

- ① Press and hold **A/B**.
- ② Press the **Number** key "2".
- ③ Press **STOP** (■), and release **A/B**.

- The Remote now can transmit B code control signals.

Plug in VCR

Plug the AC power cord back into an AC outlet.

Turn on VCR

Press **POWER** on the Remote.

- The VCR now responds to B code control signals.
- To set the Remote and the VCR back to A code control signals, repeat the same procedure as shown above except pressing the **Number** key "1" in step ■.

To control two VCRs with the same Remote

You can control two JVC VCRs by switching the remote control code for the Remote between A and B (☞ step ■), keeping two VCRs to different control codes.

- Press the **Number** key "1" for A code control signals and the **Number** key "2" for B code control signals. (To change only the remote control code for the Remote, DO NOT perform steps ■, ■, and ■.)

(Ex.) To set Remote to B code:

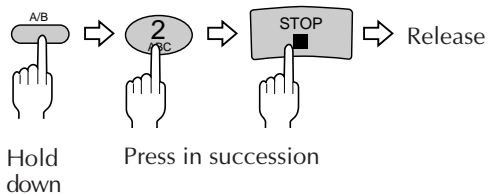

Before requesting service, use this chart and see if you can repair the trouble yourself. Small problems are often easily corrected, and this can save you the trouble of sending your VCR off for repair.

POWER

SYMPTOM	POSSIBLE CAUSE	CORRECTIVE ACTION
1. The power will not come on.	<ul style="list-style-type: none"> The AC power cord is disconnected. 	Connect the AC power cord.
2. The clock works, but the VCR's power will not come on.	<ul style="list-style-type: none"> The VCR is in the timer recording standby mode with "AUTO TIMER" set to "OFF" (☞ pg. 57). The child lock function is activated. 	<p>Press TIMER to disengage.</p> <p>Press and hold POWER on the Remote for more than seven seconds to release the child lock function (☞ pg. 62).</p>
3. The Remote will not function.	<ul style="list-style-type: none"> The batteries are discharged. 	Replace the dead batteries with new ones.

TAPE TRANSPORT

SYMPTOM	POSSIBLE CAUSE	CORRECTIVE ACTION
1. The cassette gets stuck partway during loading, and is ejected.	<ul style="list-style-type: none"> The cassette was inserted incorrectly. 	Make sure the cassette's window is facing up, the rear label side is facing you and the arrow on the front of the cassette is pointing towards the VCR. Then insert the cassette.









PLAYBACK

SYMPTOM	POSSIBLE CAUSE	CORRECTIVE ACTION
1. The tape is running but the picture will not appear.	<ul style="list-style-type: none"> If the RF connection (☞ pg. 7) is used to view the picture, the channel on the TV is set incorrectly. If the AV connection (☞ pg. 7) is used to view the picture, the TV receiver is set to the wrong mode. 	<p>Select channel 3 or 4 on the TV.</p> <p>Select the AV mode on the TV.</p>
2. Breaks are noticeable in Hi-Fi sound track.	<ul style="list-style-type: none"> Automatic tracking is engaged. 	Disengage auto tracking and adjust the tracking manually (☞ pg. 25).
3. The playback picture is blurred or interrupted, even though TV broadcasts are clear.	<ul style="list-style-type: none"> The video heads may be dirty. 	The heads must be cleaned. Consult your JVC dealer.
4. The Hi-Fi sound cannot be heard.	<ul style="list-style-type: none"> Audio Monitor setting is incorrect. 	Set Audio Monitor to "HI-FI" (☞ pg. 25 or 59).

RECORDING

SYMPTOM	POSSIBLE CAUSE	CORRECTIVE ACTION
1. Recording will not start.	<ul style="list-style-type: none"> There is no cassette loaded. The loaded cassette has had its record safety tab removed. 	<p>Insert a cassette.</p> <p>Remove the cassette and cover the hole with adhesive tape, or load a cassette on which the record safety tab is intact.</p>
2. TV broadcasts will not be recorded properly.	<ul style="list-style-type: none"> The VCR has been set to "L-1" or "F-1" input mode by mistake. 	Select the appropriate channel on the VCR.
3. Tape-to-tape editing will not work.	<ul style="list-style-type: none"> The components have been incorrectly connected, or correct video connector (S VIDEO or VIDEO) is not selected. The power to one or more of the units has not been turned on. The recording VCR's input mode has been set incorrectly. 	<p>Connect the components correctly (☞ pg. 64 – 69) or check "REAR AUX INPUT" and "FRONT AUX INPUT" setting (☞ pg. 60).</p> <p>Make sure the power to all units is on.</p> <p>Select the appropriate input mode on the recording VCR.</p>

TIMER RECORDING

SYMPTOM	POSSIBLE CAUSE	CORRECTIVE ACTION
1. Timer recording will not work.	<ul style="list-style-type: none"> • The clock and/or the timer have been set incorrectly. • The timer is not engaged. • The VCR has not been set up properly. 	<p>Set the clock and/or timer correctly.</p> <p>Press TIMER and check to make sure that  appears on the front display panel. Re-perform the set-up procedures. Make sure you have compensated for guide channel and VCR or cable box channel number mismatches (ⓘ pg. 40).</p>
2. Timer programing will not work.	<ul style="list-style-type: none"> • Timer recording is in progress. 	<p>Timer programing cannot be performed when timer recording is in progress. Wait until it finishes.</p>
3.  and  on the front display panel will not stop blinking.	<ul style="list-style-type: none"> • The timer is engaged but there is no cassette loaded. 	<p>Load a cassette with the record safety tab intact, or with the hole covered with adhesive tape.</p>
4. The cassette is automatically ejected, and  and  on the front display panel will not stop blinking.	<ul style="list-style-type: none"> • The loaded cassette has had its record safety tab removed. 	<p>Remove the cassette and cover its hole with adhesive tape, or replace it with a cassette on which the safety tab is intact.</p>
5.  blinks for 10 seconds and the timer mode is disengaged.	<ul style="list-style-type: none"> • TIMER has been pressed when there are no programs in memory, or the timer recording program has not been set correctly. 	<p>Check the programed data and set again if necessary, then press TIMER again.</p>
6. The cassette is automatically ejected, the power shuts off and  and  will not stop blinking.	<ul style="list-style-type: none"> • The tape reaches its end during timer recording. 	<p>The program may not have been recorded in its entirety. Next time be sure you have enough time on the tape to record the entire broadcast.</p>
7. Cable channels are not automatically switched during timer recording.	<ul style="list-style-type: none"> • The Controller is not properly connected to the VCR. • The output channel selected in the Cable Box Set screen is incorrect. • The cable box is turned off. 	<p>Connect the Controller correctly (ⓘ pg. 16). After confirming your cable box's output channel number, re-access the Cable Box Set screen and select the correct number (ⓘ pg. 17). Make sure the power is on before timer recording starts.</p>
8. Satellite channels are not automatically switched during timer recording.	<ul style="list-style-type: none"> • The Controller is not properly connected to the VCR. • The output channel selected in the DBS Receiver Set screen is incorrect. • The VCR is not set correctly to control the DBS receiver. • The DBS receiver is turned off. 	<p>Connect the Controller correctly (ⓘ pg. 20). After confirming your DBS receiver's output channel number, re-access the DBS Receiver Set screen and select the correct number (ⓘ pg. 21). Set the correct DBS receiver brand code (ⓘ pg. 22). Make sure the power is on before timer recording starts.</p>
9. Timer recording begins as scheduled, but the channel is always incorrect.	<ul style="list-style-type: none"> • Even though you do not use an external cable box or DBS receiver, "CABLE BOX SET" is set to "ON" or "DBS RECEIVER SET" is set to "ON". 	<p>Set "CABLE BOX SET" to "OFF" (ⓘ pg. 17) or "DBS RECEIVER SET" is set to "OFF" (ⓘ pg. 21).</p>
10. You moved, and now VCR Plus+ does not work properly.	<ul style="list-style-type: none"> • The receivable stations in the new area are received on different channels than those in the previous area. 	<p>Re-perform the Changing VCR Plus+ Setting procedure (ⓘ pg. 40).</p>
11. "PROGRAM FULL" is displayed on the screen.	<ul style="list-style-type: none"> • All 8 programs of the VCR's timer memory are used. 	<p>Wait until a space in memory clears, or cancel unnecessary program information (ⓘ pg. 44).</p>

VIDEO NAVIGATION

SYMPTOM	POSSIBLE CAUSE	CORRECTIVE ACTION
1. Tape information screen does not appear for the currently inserted tape.	<ul style="list-style-type: none"> The current tape inserted has not been recorded on this VCR. 	Tape information cannot be shown if it has not been recorded on this VCR.
2. The VCR cannot search for the correct program.	<ul style="list-style-type: none"> Two (or more) tape numbers are recorded on one tape. 	Video Navigation cannot work correctly on a tape if it has more than one tape number. If this happens, fast-forward the tape up to its end, eject it, and try it again.
3. "MEMORY FULL" appears on the screen when you try to start recording.	<ul style="list-style-type: none"> The VCR's memory for Video Navigation is fully recorded. 	Check the remaining memory (☞ pg. 51). If it is full, delete unnecessary Video Navigation information. (☞ pg. 51).

OTHER PROBLEMS

SYMPTOM	POSSIBLE CAUSE	CORRECTIVE ACTION
1. When scanning channels, some of them are skipped over.	<ul style="list-style-type: none"> Those channels have been preset to be skipped. 	If you need the skipped channels, restore them (☞ pg. 14).
2. The channel cannot be changed.	<ul style="list-style-type: none"> Recording is in progress. 	Press PAUSE (⏸) to pause the recording, change channels, then press PLAY (▶) to resume recording.
3. The Remote will not operate your TV or cable box or DBS receiver.	<ul style="list-style-type: none"> The brand codes are set incorrectly. 	Reset the correct brand codes (☞ pg. 70, 71 or 72).
4. Even though Auto or Semiauto Clock Set has been performed, the clock is incorrect.	<ul style="list-style-type: none"> The clock setting data received from the host channel is incorrect. 	Select a different host channel during Semiauto Clock Set (☞ pg. 11), or perform Manual Clock Set (☞ pg. 12).

MOISTURE CONDENSATION

Moisture in the air will condense on the VCR when you move it from a cold place to a warm place, or under extremely humid conditions—just as water droplets form on the surface of a glass filled with cold liquid. Moisture condensation on the head drum will cause damage to the tape. In conditions where condensation may occur, keep the VCR turned on for a few hours to evaporate the moisture before inserting a tape.

ABOUT HEAD CLEANING

Accumulation of dirt and other particles on the video heads may cause the playback picture to become blurred or interrupted. Be sure to contact your nearest JVC dealer if such troubles occur.

ATTENTION

This VCR contains microcomputers. External electronic noise or interference can cause microcomputer to malfunction. If the VCR does not operate correctly switch its power off and unplug the AC power cord from the AC supply. Wait for a while and then plug the power back in. Eject and check the condition of the cassette. If everything appears normal, you can operate the VCR as usual.

Questions and answers

PLAYBACK

- Q. What happens if the tape reaches its end during playback or search?**
- A. The VCR automatically rewinds it to the beginning.
- Q. Can the VCR indefinitely remain in still mode?**
- A. No. It stops automatically after 5 minutes to protect the heads.
- Q. During picture search, still picture playback and frame-by-frame playback, the picture is intermittent. What's the cause?**
- A. Picture loss occurs when these types of playback are attempted with a tape recorded in LP mode. Pressing **PLAY (▶)** to return to normal playback will restore the picture.
- Q. When returning from variable-speed picture search to normal playback, the picture is disturbed. Should I be concerned about this?**
- A. No, it is normal.
- Q. When playing back programs that have been timer-recorded consecutively (such one program from 8:00 to 9:00 and another one from 9:00 to 10:00), the picture and sound become momentarily distorted where the first program ends and the second program begins. Is this a malfunction?**
- A. No. This is normal.
- Q. Other than preventing further recording, what effect does removing the safety tab have?**
- A. It disables marking of index codes and tape numbers for Video Navigation.
- Q. Sometimes, during index search, the VCR cannot find the program I want to see. Why not?**
- A. There may be index codes too close together.
- Q. During playback, on-screen display sometimes jitters. Why does this happen?**
- A. If the condition of the tape being played back is not good, jittering of the video (including on-screen display) may occur.

RECORDING

- Q. When I pause and then resume a recording, the end of the recording before the pause is overlapped by the new recording. Why does this happen?**
- A. This is normal. It reduces distortion at the pause and resume points.
- Q. Can the VCR indefinitely remain in the recording pause mode?**
- A. No. The VCR automatically stops after 5 minutes to protect the heads. When paused during Instant Timer Recording (ITR), the VCR shuts off automatically after 5 minutes.
- Q. What happens if the tape reaches its end during recording?**
- A. The VCR automatically rewinds it to the beginning.

TIMER RECORDING

- Q. REC and ⊖ remain lit on the front display panel. Is there a problem?**
- A. No. This is a normal condition for a timer recording in progress.
- Q. Can I program the timer while I'm watching a tape or a TV broadcast?**
- A. Yes, but while you are setting the timer you will not see the tape's or broadcast program's picture as it is replaced by the on-screen menu. (The sound from the tape or broadcast program will be heard during the timer setting.)

List of terms

This guide serves as a quick way to locate frequently used terms and on-screen display names.

A

Accidental erasure prevention 33
 Audio Dubbing 67
 Audio Monitor 25, 59
 Auto Channel Set 13
 Auto Daylight Saving Time 11
 Auto SP→EP Timer 58
 Auto Timer 57
 Automatic tracking 25
 AV Connection 7
 AV Compulink 59
 AV Dubbing 68

C

Cable box setting
 Brand 17
 Installing Controller 16
 Output channel 17
 Changing VCR Plus+ Setting 40
 Channel No. indication 30
 Child Lock 62
 Clock setting 10
 Manual setting 12
 Preparations 10
 Semiauto setting 11
 Clock time 24, 30
 Connection to TV 6
 Contents 5
 Counter reset 24, 30

D

DBS receiver setting
 Brand 21
 Installing Controller 20
 Output channel 21
 Digital TBC/NR 27
 Digital R3 58

E

Editing
 Audio Dubbing 67
 AV Dubbing 68
 Insert Editing 68
 From camcorder 64
 From another VCR 66
 Remote Pause function 59
 To another VCR 66
 Express timer recording 42

F

Frame-by-Frame Playback 35
 Function Set screen 56

G

Ghost reduction 15
 Guide channel 40

H

High-Speed Picture Search 34
 Host channel 8

I

Index Search 26
 Insert Editing 68
 Instant Review 26
 Instant Timer Recording (ITR) 30

L

Language setting 9

M

Manual tracking 25
 Multi-Brand Remote
 Controlling two JVC VCRs 73
 Setting Cable Box brand 71
 Setting DBS receiver brand 72
 Setting TV brand 70

N

Navigation 46
 Next Function Memory 25

O

On-screen display 31, 80

P

PBS channel 8
 Picture Control 57
 Picture Search 34
 Playback 23
 Plug & Play 8

R

Recording 28
 Recording Resume function 33
 Recording level adjustment 32
 Remote Pause function 59
 Repeat play 25
 RF Connection 7

S

Satellite Auto Recording 61
 Second Audio Record 58
 Skip Search 27
 Slow Motion Playback 36

Special effect playback

 Frame-by-Frame Playback 35
 High-Speed Picture Search 34
 How to use the SHUTTLE ring 37
 SHUTTLE ring 35
 Picture Search 34
 Pro-Slow 36
 Slow Motion Playback 36
 Still Picture Playback 35
 Variable-Speed Picture Search 35
 Specifications 82
 Still Picture Playback 35
 Superimpose 57
 Super VHS ET 31
 S-VHS mode setting 59
 S-video connection 7

T

Tape position indicator 24
 Tape remaining time 24, 30
 Tape speed 28
 TimeScan 37
 TimeScan audio 60
 Time counter 24, 30
 Time Base Corrector 27
 Time zone selection 11
 Timer recording
 Canceling 44
 Changing 44
 Checking 44
 Express 42
 Guide channel setting 40
 Overlap 45
 VCR Plus+ 38
 Tracking 25
 Troubleshooting 74
 Tuner setting
 Adding channels 14
 Auto Channel Set 13
 Manual Channel Set 14
 Skipping channels 14

V

Variable-Speed Picture Search 35
 VCR Plus+ timer programming 38
 Video Calibration 57
 Video input setting 60
 Video Navigation 46
 Checking memory 51
 Editing titles 48
 Finding tapes 52
 Playback 46
 Video Stabilizer 58

Front panel

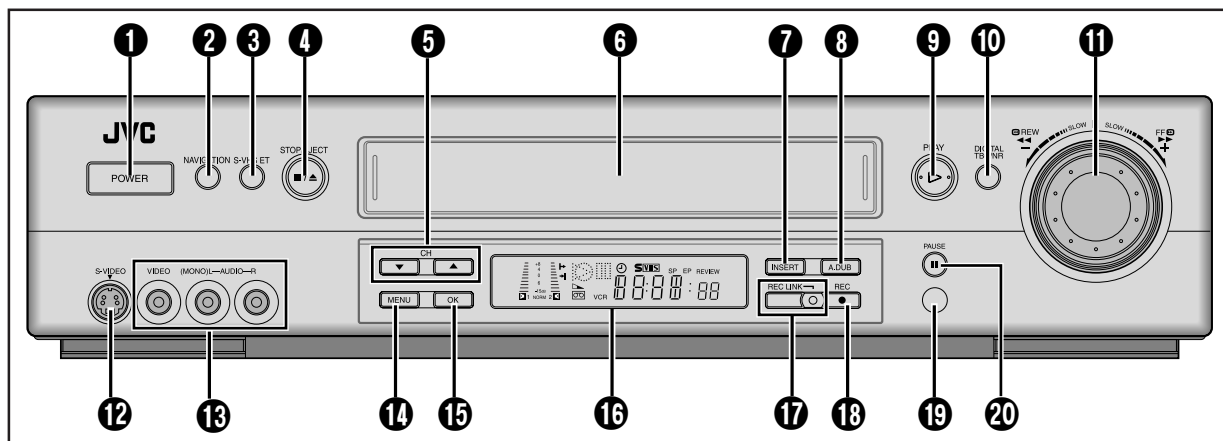

- ❶ POWER button : ☞ pg. 23, 29
- ❷ NAVIGATION button : ☞ pg. 46
- ❸ S-VHS ET button and lamp : ☞ pg. 31
- ❹ STOP/EJECT (■ / ▲) button : ☞ pg. 23, 29
- ❺ CH ▲ ▼ button : ☞ pg. 28
- ❻ Cassette loading slot
- ❼ INSERT button : ☞ pg. 69
- ❽ A. (Audio) DUB button : ☞ pg. 67, 69
- ❾ PLAY (▶) button : ☞ pg. 23
- ❿ DIGITAL TBC/NR button and lamp : ☞ pg. 27
- ⓫ TIME SCAN SHUTTLE ring : ☞ pg. 23, 29, 34
- ⓬ S-VIDEO input connector : ☞ pg. 64, 68
- ⓭ AUDIO/VIDEO input connectors : ☞ pg. 64, 67, 68
- ⓮ MENU button
- ⓯ OK button
- ⓰ Front display panel : ☞ below
- ⓱ REC LINK button and lamp : ☞ pg. 61
- ⓲ REC (●) button : ☞ pg. 28
- ⓳ Remote sensor
- ⓴ PAUSE (⏸) button : ☞ pg. 29, 35

Front display panel

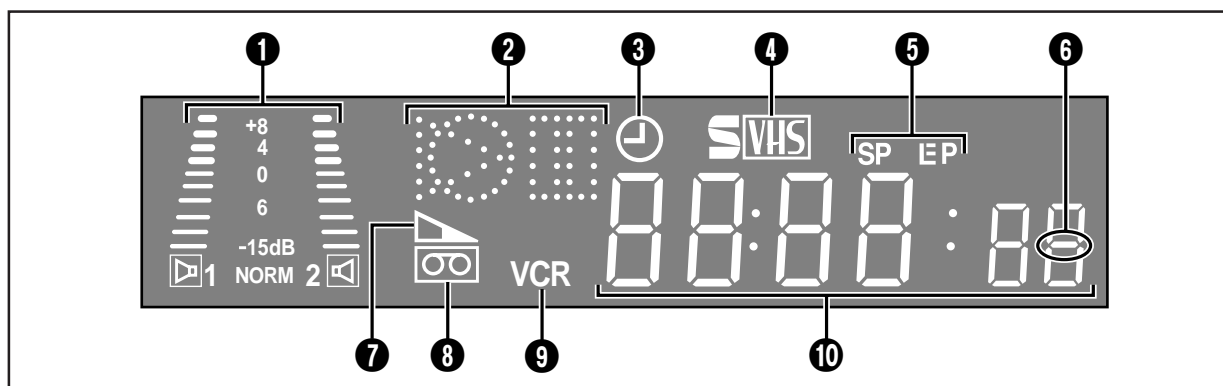

- ❶ Audio level indicator : ☞ pg. 32
- ❷ Symbolic Mode Indicators
- ❸ Timer mode indicator : ☞ pg. 39, 43
- ❹ S-VHS indicator : ☞ pg. 23, 31
- ❺ Tape speed indicators
- ❻ Child lock indicator : ☞ pg. 62
- ❼ Tape remaining time indicator : ☞ pg. 24, 30
- ❽ Cassette mark
- ❾ VCR mode indicator : ☞ pg. 28
- ⓫ Channel and auxiliary input ("L-1" and "F-1") Counter reading : ☞ pg. 24, 30
Clock time : ☞ pg. 24, 30

PLAY: FF/REW VARIABLE SHUTTLE SEARCH:		STILL: SLOW:	
		RECORD:	
		RECORD PAUSE:	
A. DUB/AV DUB:			
A. DUB PAUSE/AV DUB PAUSE:			
INSERT:			
INSERT PAUSE:			

Rear panel

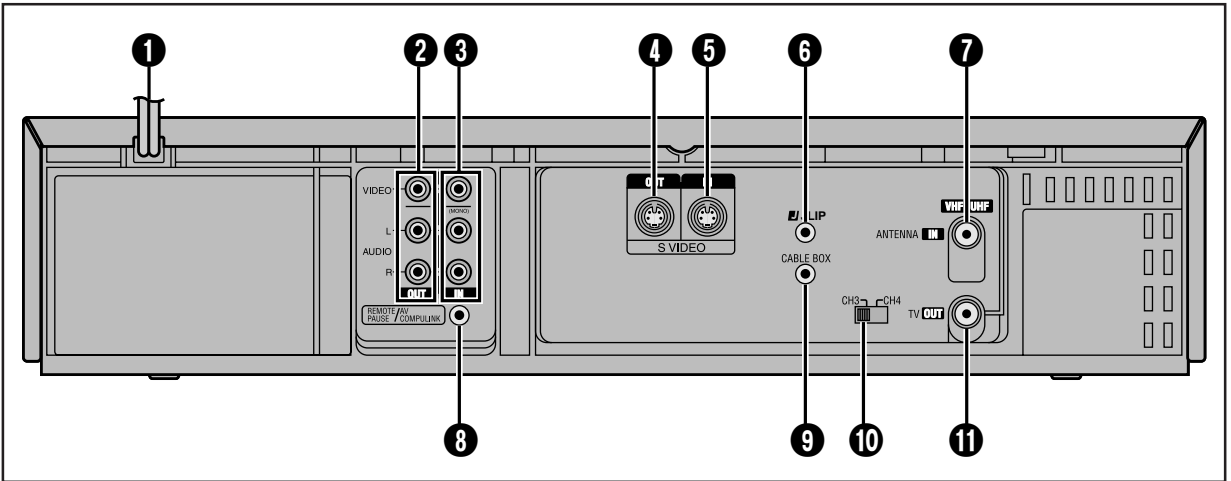

- ❶ AC power cord : [pg. 6](#)
- ❷ AUDIO/VIDEO OUT connectors : [pg. 66](#)
- ❸ AUDIO/VIDEO IN connectors : [pg. 69](#)
- ❹ S VIDEO OUT connector : [pg. 6, 66](#)
- ❺ S VIDEO IN connector : [pg. 69](#)
- ❻ J LIP terminal : [pg. 63](#)
- ❼ ANTENNA IN terminal : [pg. 6](#)
- ❽ REMOTE PAUSE/AV COMPULINK terminal
 - REMOTE PAUSE terminal : [pg. 59, 64](#)
 - AV COMPULINK terminal : [pg. 59](#)
- ❾ CABLE BOX Controller connector : [pg. 16, 20](#)
- ❿ CH3-CH4 switch : [pg. 7](#)
- ⓫ TV OUT terminal : [pg. 6](#)

On-screen display

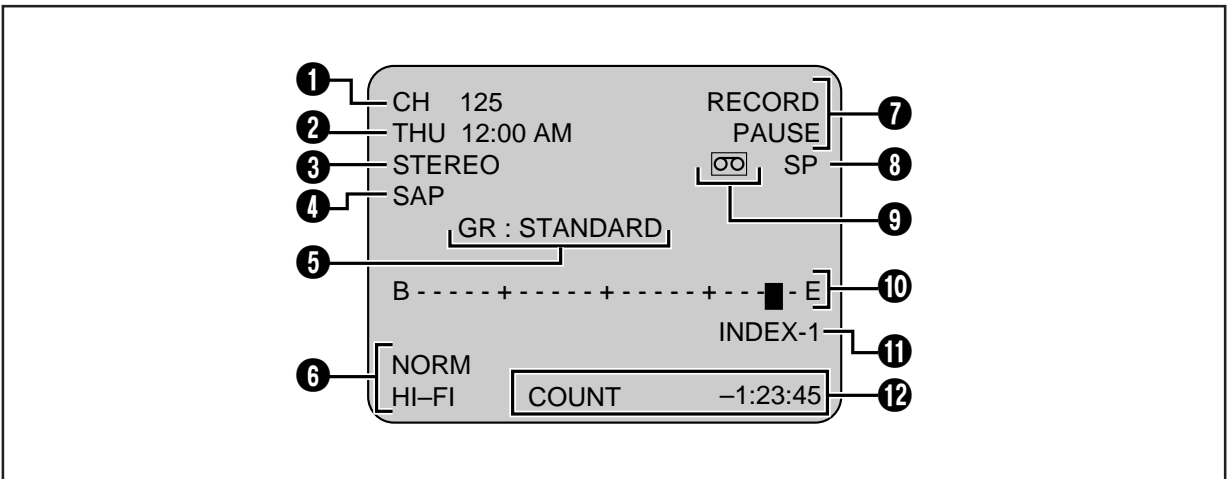

- ❶ Channel and auxiliary input ("L-1" and "F-1")
- ❷ VCR operation mode indication
- ❸ Day and clock time
- ❹ Tape speed indication
- ❺ STEREO program indication : [pg. 33](#)
- ❻ Cassette indication
- ❼ SAP (Second Audio Program) indication : [pg. 33](#)
- ❽ Tape position indicator : [pg. 24](#)
- ❾ Ghost reduction mode : [pg. 15](#)
- ❿ Index no. indication : [pg. 26](#)
- ⓫ Audio monitor indications : [pg. 25, 59](#)
- ⓫ Time counter (When "COUNT" appears)
Tape remaining time (When "REMAIN" appears)

GENERAL

Power requirement	: AC 120 V \sim , 60 Hz
Power consumption	
Power on	: 27 W
Power off	: 2.6 W
Temperature	
Operating	: 5°C to 40°C (41°F to 104°F)
Storage	: -20°C to 60°C (-4°F to 140°F)
Operating position	: Horizontal only
Dimensions (W x H x D)	: 437 mm x 97 mm x 347 mm (17-1/4" x 3-7/8" x 13-11/16")
Weight	: 4.8 kg (10.6 lbs)
Format	: S-VHS/VHS NTSC standard
Maximum recording time	
SP	: 210 min. with ST-210 video cassette
EP	: 630 min. with ST-210 video cassette

VIDEO/AUDIO

Signal system	: NTSC-type color signal and EIA monochrome signal, 525 lines/60 fields
Recording/ Playback system	: DA-4 (Double Azimuth) head helical scan system
Signal-to-noise ratio	: 45 dB
Horizontal resolution	
VHS	: 230 lines
S-VHS	: 400 lines
Frequency range	
Normal audio	: 70 Hz to 10,000 Hz
Hi-Fi audio	: 20 Hz to 20,000 Hz
Input/Output	: RCA connectors (IN x 2, OUT x 1) S-video connectors (IN x 2, OUT x 1)

TUNER

Tuning system	: Frequency-synthesized tuner
Channel coverage	
VHF	: Channels 2-13
UHF	: Channels 14-69
CATV	: 113 Channels
RF output	: Channel 3 or 4 (switchable; preset to Channel 3 when shipped) 75 Ω , unbalanced

TIMER

Clock reference	: Quartz
Program capacity	: 1-year programmable timer/ 8 programs
Memory backup time	: Approx. 3 min.

ACCESSORIES

Provided accessories	: Infrared remote control unit, "AA" battery x 2, Audio/video cable, RF cable (F-type), S-video cable (4-pin), S-VHS ET labels, Controller
----------------------	--

Specifications shown are for SP mode unless specified otherwise.

E. & O.E. Design and specifications subject to change without notice.

Usable cassettes

Full-Size VHS

T-30 (ST-30**)

T-60 (ST-60**)

T-90

T-120 (ST-120**)

T-160 (ST-160**)

ST-210**

Compact VHS*

TC-20 (ST-C20**)

TC-30 (ST-C30**)

TC-40 (ST-C40**)

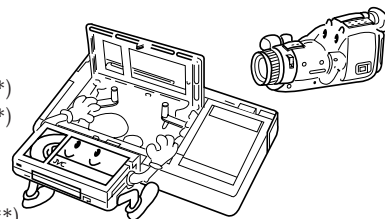

* Compact VHS camcorder recordings can be played on this video recorder. Simply place the recorded cassette into a VHS Cassette Adapter and it can be used just like any full-sized VHS cassette.

** This VCR can record on regular VHS and Super VHS cassettes. While only VHS signals can be recorded on regular VHS cassettes ¹⁾, both VHS and Super VHS signals can be recorded and played back using Super VHS cassettes.

¹⁾ By using the S-VHS ET function, it is possible to record and play back with S-VHS picture quality on VHS cassettes on this VCR.

HOW TO LOCATE YOUR JVC SERVICE CENTER**TOLL FREE: 1-800-252-5722****<http://www.jvcservice.com>****Dear customer:**

In order to receive the most satisfaction from your purchase, read the instruction booklet before operating the unit. In the event that repair is necessary, or for the address nearest your location, please refer to the factory service center list below or within the Continental United States, call 1-800-252-5722 for your authorized servicer. Remember to retain your Bill of Sale for Warranty Service.

— JVC

**JVC SERVICE & ENGINEERING
COMPANY OF AMERICA
DIVISION OF JVC AMERICAS CORP.**

FACTORY SERVICE CENTER LOCATIONS

10 New Maple Avenue
Pine Brook, NJ 07058-9641
(973) 396-1000

1500 Lakes Parkway
Lawrenceville, GA 30243-5857
(770) 339-2522

705 Enterprise Street
Aurora, IL 60504-8135
(630) 851-7855

5665 Corporate Avenue
Cypress, CA 90630-4727
(714) 229-8011

10700 Hammerly Boulevard, Suite 110
Houston, TX 77043-2310
(713) 935-9331

2969 Mapunapuna Place, Suite 105
Honolulu, HI 96819-2000
(808) 833-5828

13 Cummings Park
Woburn, MA 01801-2105
(781) 376-9100

8192 W State Road 84
Davie, FL 33324-4611
(954) 472-1960

890 Dubuque Avenue
South San Francisco, CA 94080-1804
(650) 871-2666

Sophisticated electronic products may require occasional service. Just as quality is a keyword in the engineering and production of the wide array of JVC products, service is the key to maintaining the high level performance for which JVC is world famous. The JVC service and engineering organization stands behind our products.

NATIONAL HEADQUARTERS
JVC SERVICE & ENGINEERING COMPANY OF AMERICA
DIVISION OF JVC AMERICAS CORP.
10 New Maple Avenue
Pine Brook, NJ 07058-9641

If you ship the product...

Pack your JVC unit in the original carton or one of equivalent size and strength. Enclose, with the unit, a letter stating the problem or symptom that exists and also a copy of the receipt or bill of sale you received when you purchased your JVC unit. Print your home return address on the outside and the inside of the carton. Send to the appropriate JVC Factory Service Center as listed above.

Don't service it yourself.**CAUTION**

To prevent electrical shock, do not open the cabinet. No user serviceable parts inside. Refer servicing to qualified service personnel.

ACCESSORIES

To purchase accessories for your JVC product, you may contact your local JVC Dealer. Or from the 48 Continental United States call toll free: 1-800-882-2345.

LIMITED WARRANTY

CONSUMER VIDEO 1-90

JVC COMPANY OF AMERICA warrants this product and all parts thereof, except as set forth below ONLY TO THE ORIGINAL PURCHASER AT RETAIL to be FREE FROM DEFECTIVE MATERIALS AND WORKMANSHIP from the date of original retail purchase for the period as shown below. ("The Warranty Period")

PARTS	1 YR	LABOR	90 DAYS
-------	-------------	-------	----------------

THIS LIMITED WARRANTY IS VALID ONLY IN THE FIFTY (50) UNITED STATES, THE DISTRICT OF COLUMBIA AND IN COMMONWEALTH OF PUERTO RICO.

WHAT WE WILL DO:

If this product is found to be defective, JVC will repair or replace defective parts at no charge to the original owner. Such repair and replacement services shall be rendered by JVC during normal business hours at JVC authorized service centers. Parts used for replacement are warranted only for the remainder of the Warranty Period. All products and parts thereof may be brought to a JVC authorized service center on a carry-in basis except for Television sets having a screen size 25 inches and above which are covered on an in-home basis.

WHAT YOU MUST DO FOR WARRANTY SERVICE:

Return your product to a JVC authorized service center with a copy of your bill of sale. For your nearest JVC authorized service center, please call toll free: (800) 252-5722.

If service is not available locally, box the product carefully, preferably in the original carton, and ship, insured, with a copy of your bill of sale plus a letter of explanation of the problem to the nearest JVC Factory Service Center, the name and location of which will be given to you by the toll-free number.

If you have any questions concerning your JVC Product, please contact our Customer Relations Department.

WHAT IS NOT COVERED:

This limited warranty provided by JVC does not cover:

1. Products which have been subject to abuse, accident, alteration, modification, tampering, negligence, misuse, faulty installation, lack of reasonable care, or if repaired or serviced by anyone other than a service facility authorized by JVC to render such service, or if affixed to any attachment not provided with the products, or if the model or serial number has been altered, tampered with, defaced or removed;
2. Initial installation and installation and removal for repair;
3. Operational adjustments covered in the Owner's Manual, normal maintenance, video and audio head cleaning;
4. Damage that occurs in shipment, due to act of God, and cosmetic damage;
5. Signal reception problems and failures due to line power surge;
6. Video Pick-up Tubes/CCD Image Sensor, Cartridge, Stylus (Needle) are covered for 90 days from the date of purchase;
7. Accessories;
8. Batteries (except that Rechargeable Batteries are covered for 90 days from the date of purchase); from the date of purchase);

There are no other express warranties except as listed above.

THE DURATION OF ANY IMPLIED WARRANTIES INCLUDING THE IMPLIED WARRANTY OF MERCHANTABILITY, IS LIMITED TO THE DURATION OF THE EXPRESS WARRANTY HEREIN.

JVC SHALL NOT BE LIABLE FOR THE LOSS OF USE OF THE PRODUCT, INCONVENIENCE, LOSS OR ANY OTHER DAMAGES, WHETHER DIRECT, INCIDENTAL OR CONSEQUENTIAL (INCLUDING, WITHOUT LIMITATION, DAMAGE TO TAPES, RECORDS OR DISCS) RESULTING FROM THE USE OF THIS PRODUCT, OR ARISING OUT OF ANY BREACH OF THIS WARRANTY. ALL EXPRESS AND IMPLIED WARRANTIES, INCLUDING THE WARRANTIES OF MERCHANTABILITY AND FITNESS FOR PARTICULAR PURPOSE, ARE LIMITED TO THE WARRANTY PERIOD SET FORTH ABOVE.

Some states do not allow the exclusion of incidental or consequential damages or limitations on how long an implied warranty lasts, so these limitations or exclusions may not apply to you. This warranty gives you specific legal rights and you may also have other rights which vary from state to state.

JVC COMPANY OF AMERICA
DIVISION OF JVC AMERICAS CORP.

1700 Valley Road
Wayne, New Jersey 07470

REFURBISHED PRODUCTS CARRY A SEPARATE WARRANTY, THIS WARRANTY DOES NOT APPLY. FOR DETAILS OF REFURBISHED PRODUCT WARRANTY, PLEASE REFER TO THE REFURBISHED PRODUCT WARRANTY INFORMATION PACKAGED WITH EACH REFURBISHED PRODUCT.

For customer use:

Enter below the Model No. and Serial No. which is located either on the rear, bottom or side of the cabinet. Retain this information for future reference.

Model No.: _____

Serial No.: _____

Purchase date: _____

Name of dealer: _____

HR-S9800U

